PRODUCT CATALOG (IEC)

Low-power UPS



0 Disclaimer

Terms and Conditions

The ABB Power Protection SA sales terms and conditions are valid for any items purchased from ABB Power Protection SA unless otherwise stated and agreed upon.

ABB's latest warranty terms and conditions are applicable unless otherwise stated and agreed upon. See the contact page at the end of this catalog for more information on obtaining the latest warranty terms and conditions.

Technical

The information in this catalogue regarding UPS autonomy refers to a typical operation scenario. Refer to the product datasheet for a complete overview of the battery runtime.

The technical specifications in this document are subject to change without notice at the sole discretion of ABB Power Protection SA.

Table of contents

002–003	0 Disclaimer
004–009	1 UPS introduction
010–011	2 Product overview
012–013	3 PowerValue 11LI Up
014–015	4 PowerValue 11LI Pro
016–021	5 PowerValue 11T G2 1-10 kVA
022–026	6 PowerValue 11RT G2
027–031	7 PowerValue 11 / 31 T
032–037	8 PowerScale 33 10-50 kVA
038–046	9 Accessories
047–047	10 Warranty matrix and extension pricelist

1 UPS introduction

What is a UPS?



Electronic equipment supporting critical systems—such as telecommunication servers, LAN nodes, and computers—requires a continuous supply of power. In some cases, even a minor disruption in power can cause damage to the equipment, data loss, an interruption of vital communication channels, or disturb potentially life-saving equipment.

A guaranteed way to ensure critical systems maintain power during electrical variances is with an uninterruptible power supply (UPS). A UPS is a continuous power system protecting electronic equipment from unexpected power disruptions during mains failures and other power interruptions.

In the event of power failure or if the mains voltage falls below minimum levels, the UPS maintains continuous power to electronic equipment until the mains is restored, a shutdown sequence is performed, or a backup generator resumes power.

Unlike a UPS, a backup generator can provide electricity for a long period during outages. However, there will be a short interruption in the power supply while the generator comes up to speed. Further, a generator does not prevent power disruptions to equipment in the event of an outage, blackout, power surge, spikes, etc. This means important, even life-saving, electrical equipment either shuts down, restarts, or becomes damaged during power interruptions. A UPS stands apart from an emergency power system or a backup generator in that it provides continuous or near-instantaneous power when a failure occurs.

Why a UPS?

01 Common power disruptions

The short answer is that our modern world is nearly totally reliant upon electricity, and there are natural and environmental conditions as well as human errors that cause disruptions in power.

A sudden loss of power will disrupt most business, government, and business, commercial and government operations. There are many examples of companies that have gone into liquidation as a consequence of mains power failure. However, it is not only total mains power failures or "blackouts" that can trigger devastating effects. Many electrical loads, such as computer systems, are equally susceptible to:

- Power sags
- Brownouts
- Blackouts
- Power spikes and surges
- Noise and radio-frequency interference
- Supply frequency changes

These are common types of power loss that affect and damage sensitive electrical systems. See the figure below for an example of common power disruptions.

Such loads are often referred to as "critical loads", partly because their continuous operation is fundamental to the functioning of the business and because they require a more stable and reliable power source than that generally offered by the utility mains supply in order to guarantee their correct function.

A UPS provides a simple and efficient way to ensure our world remains operational. There are critical telecommunication systems that we rely upon every day to conduct business, save lives and perform daily tasks. Our businesses, our emergency response systems, our medical institutions and even our homes all rely on an uninterrupted source of clean power.

These telecommunication systems operate on a multitude of pieces of electronic equipment – computers, servers, LAN nodes, etc. – and this equipment must maintain continuous operation. Interruptions in power are a detriment to commercial and government organizations – blackouts, brownouts, power surges, and spikes are just a few interruptions the UPS protects electrical equipment from.

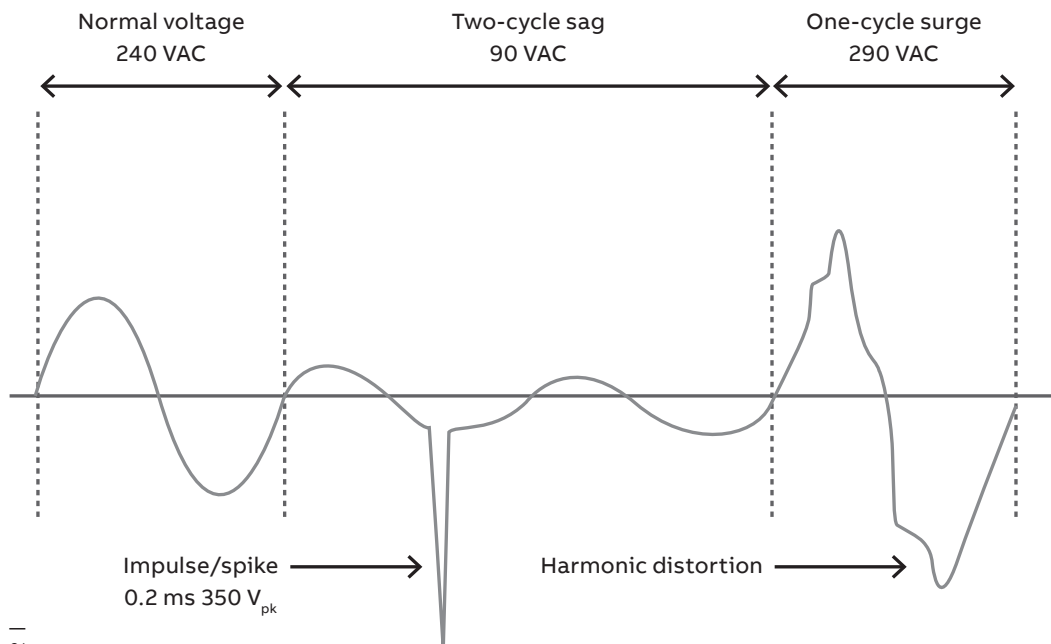

UPS topologies

Offline/standby

—
02 Offline/
standby UPS

An offline/standby UPS offers basic surge protection and continuous power from a backup battery.

The figure shows an offline UPS model during normal operation, mains failure and UPS failure. The offline UPS design protects equipment by powering the critical loads from the bypass line (ie, the raw mains) and then transferring power to the inverter if the bypass supply fails, or if the voltage goes above or below the acceptable preset limits.

During normal operation, equipment may experience several mains disturbances that are within the acceptable limits, but the offline UPS includes spike suppression and radio frequency (RF) filtering within its bypass circuit.

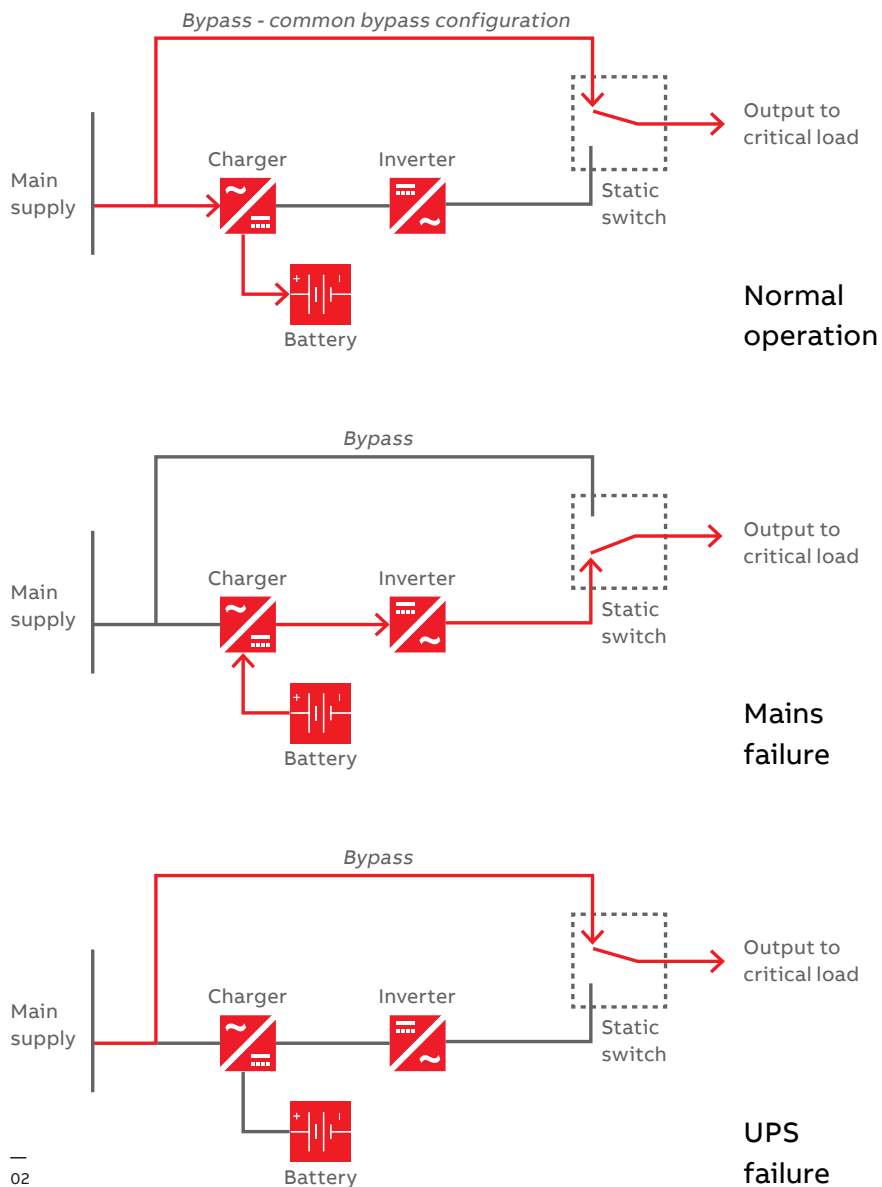

Line-interactive

—
03 Line-inter-
active UPS

The line-interactive UPS operates similarly to the offline/standby UPS in that it typically supplies the critical load through the bypass line and then transfers it to the inverter in the event of a bypass supply failure. The line-interactive system utilizes the battery, charger and inverter in the same manner as the offline/standby unit, but with added circuit regulators in the bypass line. This regulator transfers the load to the battery-fed inverter supply less frequently, which makes the line-interactive UPS more efficient in operation costs and battery wear and tear compared to the offline/standby UPS system.

The figure shows the line-interactive UPS system during normal operation and mains failure. During normal operation, the mains supply powers the electrical load through the bypass line and charges the battery if needed. During mains failure, the battery supplies power to the inverter which provides power to the electrical load.

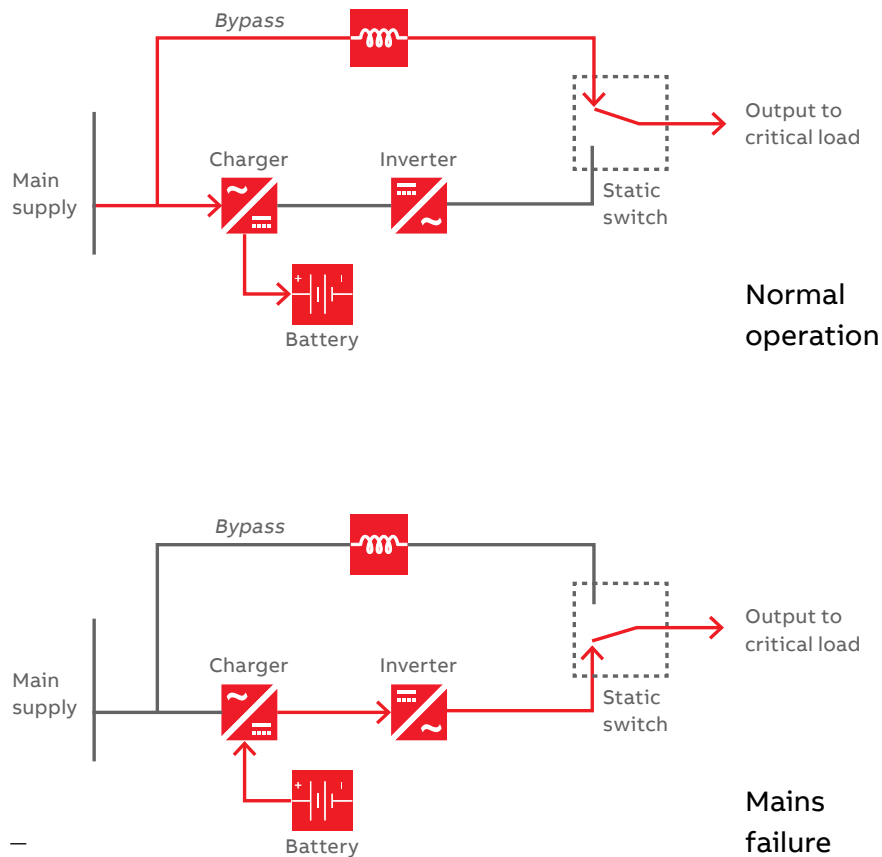

—
03

Online/double-conversion

An online UPS offers the most comprehensive solution in uninterruptible power. The online UPS system replaces the battery charger with a rectifier/charger block, which is either two separate units or a combined power block.

The figure below illustrates the online UPS system during normal operation, mains failure and UPS failure on bypass mode. When mains power is present, this power block charges the battery and supplies the inverter with a steady voltage supply. During mains failure, the UPS rectifier drops from the circuit, allowing the batteries to maintain constant and uninterrupted power. When power is restored, the rectifier begins carrying most of the load and recharging the batteries.

The rectifier/charger has a control feature that has an input current limit feature that protects critical equipment that is sensitive to minor power fluctuations from losing power. This type of UPS is perfect for environments containing sensitive electrical equipment that mandates isolation.

This UPS is also known as the double conversion UPS due to its two conversion stages of AC-DC and DC-AC. The double conversion UPS offers the greatest degree of critical power supply integrity. When the UPS input mains supply is present, the rectifier, charger, and inverter power blocks are all active and the load is connected to the inverter output from the static switch. As the load is powered from the inverter during normal operation circumstances, it is protected from power fluctuations and disturbances since the rectifier and inverter act as a “firewall” between the equipment and mains power voltage fluctuations.

If the mains input supply fluctuates above or below a preset voltage range (typically +10% to -20%) or suffers a total failure, the inverter continues operating from battery power and the event is completely transparent to the electrical load. This is because there is no power transfer operation involved.

When operating from battery power, the inverter supplies steady regulation as when the mains is present. If the mains power is not restored before the battery is depleted, then the inverter shuts down.

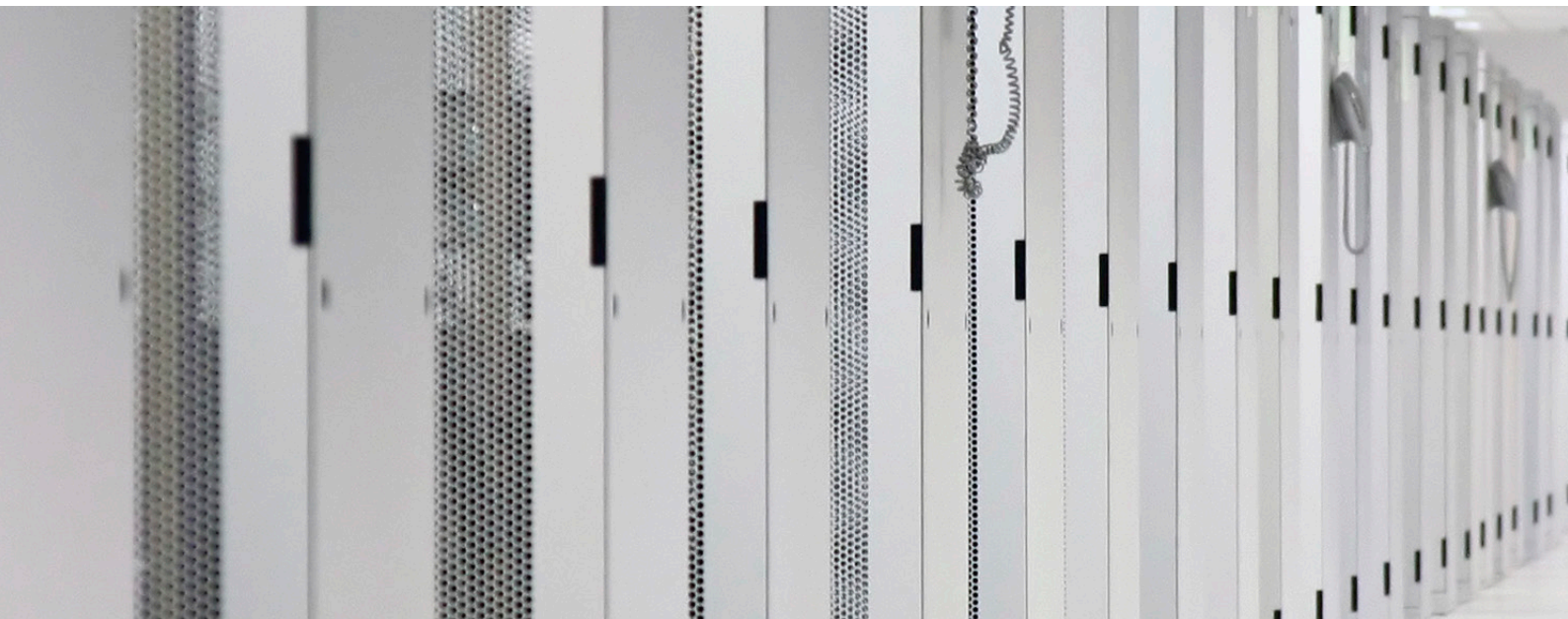

—
04 Online/double-
conversion UPS

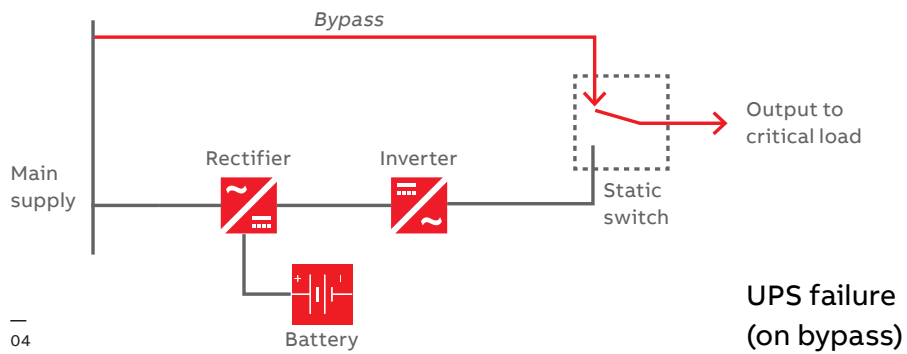
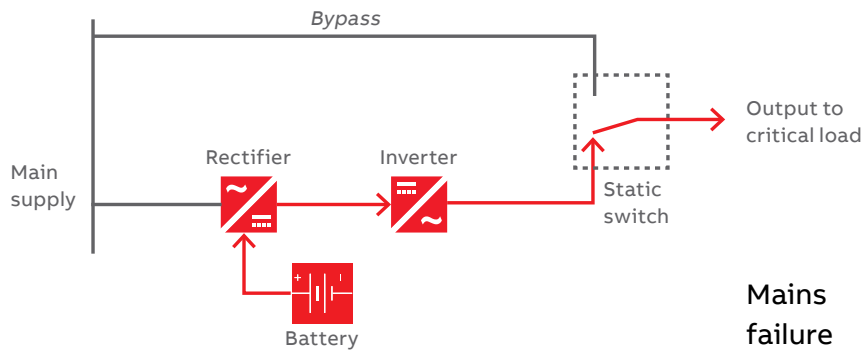
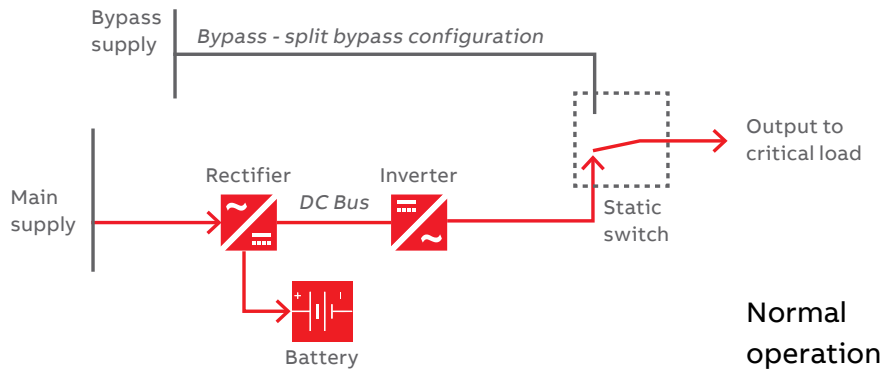

—
04



2 Product overview

UPS rated power and overview

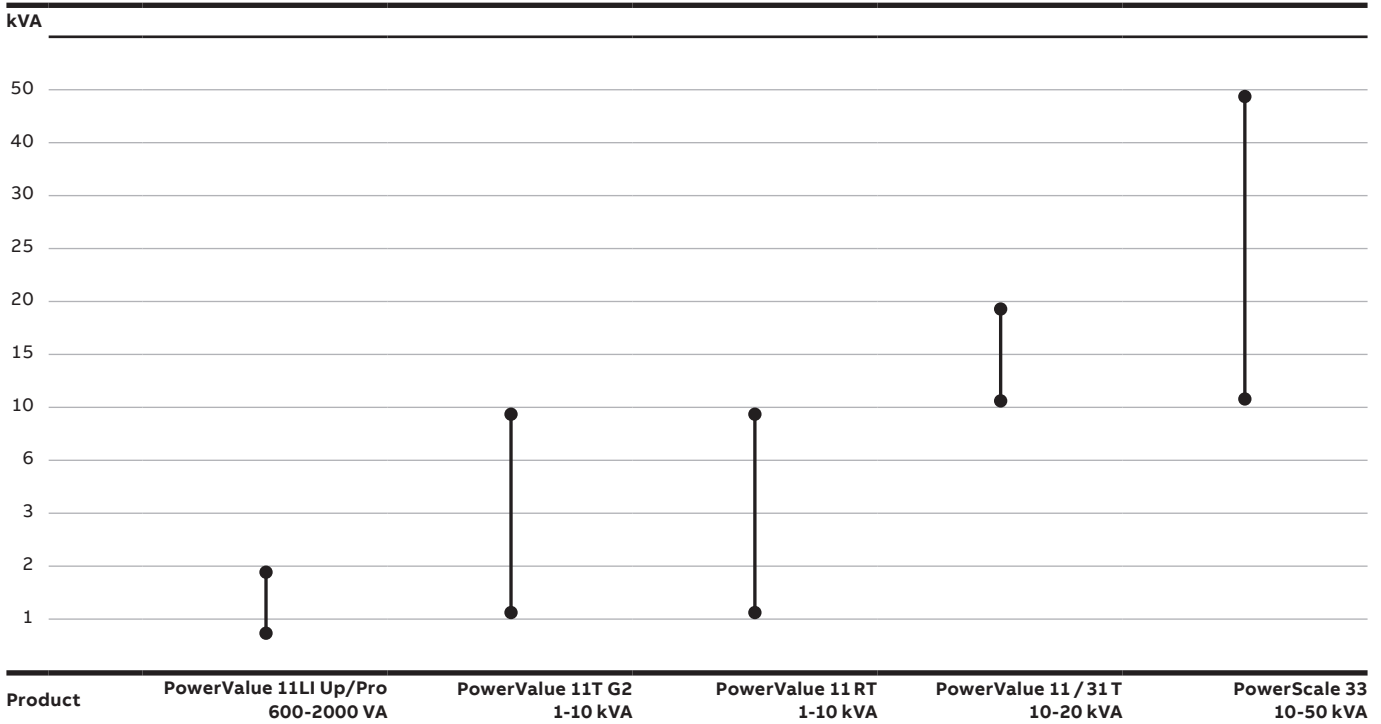

Product	PowerValue 11LI Up/Pro 600-2000 VA	PowerValue 11T G2 1-10 kVA	PowerValue 11 RT 1-10 kVA	PowerValue 11 / 31 T 10-20 kVA	PowerScale 33 10-50 kVA
					
Description	Cost-effective power protection and automatic voltage correction for lower-power operations and entry-level network applications such as server rooms in offices, workstations and point-of-sale.	Cost-effective power protection for entry-level server rooms, lab equipment, ATM and other sensitive electronic devices	Professional single-phase UPS for the most demanding applications, it maintains the power for critical servers, PoS, workstations, clusters and eliminates the incoming power disturbances. The thinnest and fully rack-tower convertible module available in the market (2U only)	The ideal power protection for large IT rooms, networks and critical applications with its high power capability and redundancy	The high-performance three-phase UPS for low-power applications to minimize your total cost of ownership (TCO) providing state-of-art and flexible power uptime



3 PowerValue 11LI Up

A line-interactive UPS to suit all pockets



Intended for users with lower power requirements, the line-interactive PowerValue 11LI Up delivers from 600 up to 2,000 VA electrical power, making it the ideal UPS for modest IT applications. As well as intervening within 2 to 6 ms to power your application when mains power is lost, the PowerValue 11LI Up also filters out input power disturbances such as surges, line noise or brownouts. If the input power factor starts to play up, the PowerValue 11LI Up will automatically correct it.

This UPS solution has been created to make life easy for the user:

- An intuitive touchscreen display allows parameters to be read with the minimum of fuss.

Enhanced runtime

- Up to four minutes autonomy with typical IT load
- High quality batteries ensure stable performance over years
- Minimize the costs related to battery maintenance and replacement

Compact size

- Small footprint
- Easy to place nearby a laptop or monitor

- USB and RS232 interfaces give access to the outside world.
- Dedicated RJ11/RJ45 sockets protect connected telecoms devices.

The UPS's internal enhanced-runtime batteries are designed to give you stable, low-maintenance performance over many years of service. When they eventually have to be replaced, this can be done without opening the cabinet. The slot to access the batteries is located at the bottom. A comprehensive battery management suite and fan cooling ensure batteries are not overloaded and that they do not overcharge, discharge too deeply or overheat.

Easy battery replacement

- Change your battery in seconds
- Easy and safe access to the internal battery
- No need to dismantle the whole cabinet

Touchscreen LCD display

- All information in a tap
- More user friendly than a LED interface

PowerValue 11LI Up 600-2,000 VA

Available models, technical specifications & ordering info

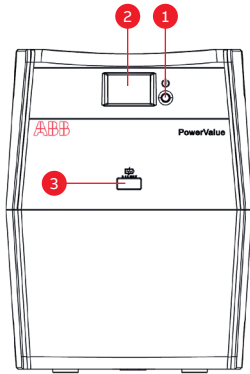

600-2000 VA
Front view

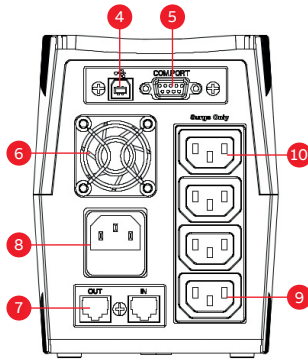

600-800 VA
Rear view

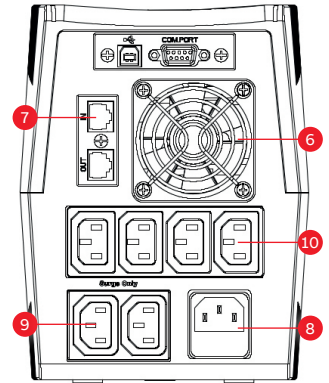

1000-1500-2000 VA
Rear view

1. Standby/line mode button and power LED	4. USB	7. RJ11/RJ45 data protection	10. Backup sockets
2. Touchscreen LCD display	5. RS232	8. AC input	
3. USB charger (5 V, 2 A)	6. Fan	9. Surge only sockets	

Technical specifications

	11LI Up 600VA	11LI Up 800VA	11LI Up 1000VA	11LI Up 1500VA	11LI Up 2000VA
Rated power	360 W	480 W	600 W	900 W	1200 W
Nominal AC input/output voltage	230 VAC	230 VAC	230 VAC	230 VAC	230 VAC
AC input voltage window	170 – 280 VAC	170 – 280 VAC	170 – 280 VAC	170 – 280 VAC	170 – 280 VAC
AC output voltage tolerance	-17.1 % / +15.5% (line mode) +10% (battery mode)	-17.1 % / +15.5% (line mode) +10% (battery mode)	-17.1 % / +15.5% (line mode) +10% (battery mode)	-17.1 % / +15.5% (line mode) +10% (battery mode)	-17.1 % / +15.5% (line mode) +10% (battery mode)
Input Frequency	50 / 60 Hz	50 / 60 Hz	50 / 60 Hz	50 / 60 Hz	50 / 60 Hz
Output Frequency	50 Hz (60 Hz) ± 1 Hz	50 Hz (60 Hz) ± 1 Hz	50 Hz (60 Hz) ± 1 Hz	50 Hz (60 Hz) ± 1 Hz	50 Hz (60 Hz) ± 1 Hz
Efficiency	≥95%	≥95%	≥95%	≥95%	≥95%
Transfer time	2-6 ms	2-6 ms	2-6 ms	2-6 ms	2-6 ms
Battery type	1x7.2 Ah	1x8 Ah	2x7.2 Ah	2x8 Ah	2x8 Ah
Battery recharge time	6-8 hrs	6-8 hrs	6-8 hrs	6-8 hrs	6-8 hrs
Runtime in minutes at typical load (60%)	1' 55"	1' 27"	3' 17"	4' 10"	2' 24"
Ambient temperature	0-40°C	0-40°C	0-40°C	0-40°C	0-40°C
Max rel. humidity	0-90% not condensing	0-90% not condensing	0-90% not condensing	0-90% not condensing	0-90% not condensing
Storage temperature	-20 to 50°C	-20 to 50°C	-20 to 50°C	-20 to 50°C	-20 to 50°C
Net weight	4.1 kg	4.7 kg	7.5 kg	9.8 kg	10.7 kg
Dimensions (WxHxD)	122x160x315 mm	122x160x315 mm	145x190x335 mm	145x190x335 mm	145x190x335 mm

Ordering info table

UPS	Article number	Power (VA/W)	Typical runtime (min)	Dimensions WxHxD (mm)	Weight (kg)
PowerValue 11LI Up 600 VA	4NWP100170R0001	600/360	1'55"	122x160x315	4.1
PowerValue 11LI Up 800 VA	4NWP100171R0001	800/480	1'27"	122x160x315	4.7
PowerValue 11LI Up 1000 VA	4NWP100172R0001	1000/600	3'17"	145x190x335	7.5
PowerValue 11LI Up 1500 VA	4NWP100173R0001	1500/900	4'10"	145x190x335	9.8
PowerValue 11LI Up 2000 VA	4NWP100174R0001	2000/1200	2'24"	145x190x335	10.7

4 PowerValue 11LI Pro

A line-interactive UPS ideal for entry-level network equipment



Intended for entry-level network applications – such as server rooms in offices, network cabinets, work-station clusters, domestic networks, point-of-sale, network-attached data storage arrays and similar-sized situations – the line-interactive PowerValue 11LI Pro delivers from 600 up to 2,000 VA electrical power. This advanced protection ensures your connected equipment always sees a clean, regulated and reliable pure sinusoidal voltage.

This UPS solution has been created to make life easy for the user:

- An intuitive LCD display allows parameters to be read with the minimum of fuss.
- USB and RS232 interfaces give access to the outside world.
- Dedicated RJ11/RJ45 sockets protect connected telecoms devices.

Enhanced runtime

- Up to six minutes with typical IT load
- High quality batteries ensure stable performance over years
- Minimize the costs related to battery maintenance and replacement

Compact size

- Small footprint
- Easy to place nearby a laptop or monitor, underneath a table or at the bottom of an IT rack

The UPS's internal enhanced-runtime batteries are designed to give you stable, low-maintenance performance over many years of service. When they eventually have to be replaced, this can be done by opening only the front panel. A comprehensive battery management suite and fan cooling ensure batteries are not overloaded and that they do not over-charge, discharge too deeply or overheat.

ABB's design, technology and quality experience in high-end UPS engineering has been distilled into the line-interactive PowerValue 11LI Pro to produce a UPS that offers full protection and peace of mind for your moderately sized IT applications.

Easy battery replacement

- Change your battery in seconds
- Easy and safe access to the internal battery
- No need to dismantle the whole cabinet

Pure sinewave output

- Less harmonics content, lower fan speed and reduced acoustic noise
- Improved load performance and prolonged lifetime

PowerValue 11LI Pro 600–2,000 VA

Available models, technical specifications & ordering info

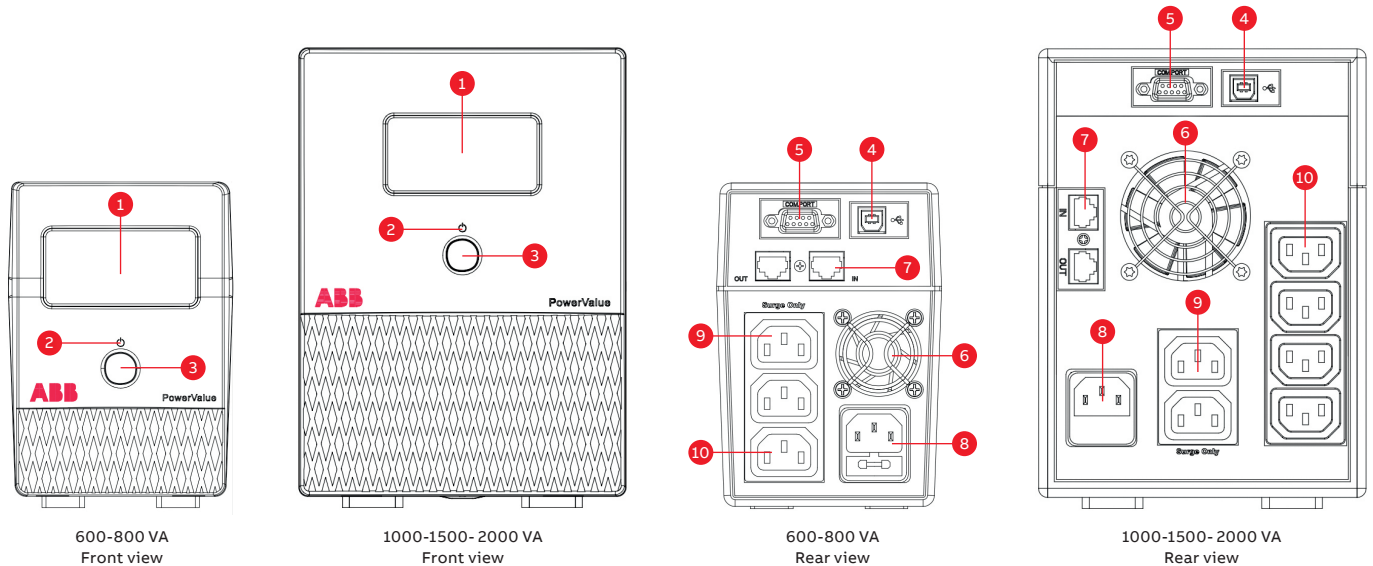

1. LCD display	4. USB	7. RJ11/RJ45 data protection	10. Backup sockets
2. Power LED	5. RS232	8. AC input	
3. On/off button	6. Fan	9. Surge only sockets	

Technical specifications

	11LI Pro 600VA	11LI Pro 800VA	11LI Pro 1000VA	11LI Pro 1500VA	11LI Pro 2000VA
Rated power	360 W	480 W	700 W	1050 W	1400 W
Nominal AC input/output voltage	230 VAC	230 VAC	230 VAC	230 VAC	230 VAC
AC input voltage window	170 – 280 VAC	170 – 280 VAC	170 – 280 VAC	170 – 280 VAC	170 – 280 VAC
AC output voltage tolerance	-17.1 % / +15.5% (line mode) +10% (battery mode)	-17.1 % / +15.5% (line mode) +10% (battery mode)	-17.1 % / +15.5% (line mode) +10% (battery mode)	-17.1 % / +15.5% (line mode) +10% (battery mode)	-17.1 % / +15.5% (line mode) +10% (battery mode)
Input Frequency	50 / 60 Hz	50 / 60 Hz	50 / 60 Hz	50 / 60 Hz	50 / 60 Hz
Output Frequency	50 Hz (60 Hz) ± 1 Hz	50 Hz (60 Hz) ± 1 Hz	50 Hz (60 Hz) ± 1 Hz	50 Hz (60 Hz) ± 1 Hz	50 Hz (60 Hz) ± 1 Hz
Efficiency	≥95%	≥95%	≥95%	≥95%	≥95%
Transfer time	2-6 ms	2-6 ms	2-6 ms	2-6 ms	2-6 ms
Battery type	1x7.2 Ah	1x8 Ah	2x7.2 Ah	2x8 Ah	2x9.4 Ah
Battery recharge time	6-8 hrs	6-8 hrs	6-8 hrs	6-8 hrs	6-8 hrs
Runtime in minutes at typical load (60%)	3'30"	2'30"	5' 51"	5' 08"	3' 01"
Ambient temperature	0-40°C	0-40°C	0-40°C	0-40°C	0-40°C
Max rel.humidity	0-90% not condensing	0-90% not condensing	0-90% not condensing	0-90% not condensing	0-90% not condensing
Storage temperature	-20 to 50°C	-20 to 50°C	-20 to 50°C	-20 to 50°C	-20 to 50°C
Net weight	6 kg	6.6 kg	8 kg	11.1 kg	11.9 kg
Dimensions (WxHxD)	100x142x330 mm	100x142x330 mm	146x200x392 mm	146x200x392 mm	146x200x392 mm

Ordering info table

UPS	Article number	Power (VA/W)	Typical runtime (min)	Dimensions WxHxD (mm)	Weight (kg)
PowerValue 11LI Pro 600 VA	4NWP100175R0001	600/360	3'30"	100x142x330	6.0
PowerValue 11LI Pro 800 VA	4NWP100176R0001	800/480	2'30"	100x142x330	6.6
PowerValue 11LI Pro 1000 VA	4NWP100177R0001	1000/700	5'51"	146x200x392	8.0
PowerValue 11LI Pro 1500 VA	4NWP100178R0001	1500/1050	5'08"	146x200x392	11.1
PowerValue 11LI Pro 2000 VA	4NWP100179R0001	2000/1400	3'01"	146x200x392	11.9

5 PowerValue 11T G2 1-10 kVA

A cost-effective solution for maximum power protection



ABB's PowerValue 11T G2 is a single-phase in/out, double conversion online uninterruptible power supply (UPS) that guarantees up to 10 kW per single UPS of clean, reliable power for your critical single-phase applications. As well as maintaining power to your server room, advertising display, turnstiles, lab equipment, transportation signaling systems, ATM or vending machine, the PowerValue 11T G2 also conditions incoming power to eliminate spikes, swells, sags, noise and harmonics.

Featuring voltage and frequency independent (VFI) topology, the tower-only PowerValue 11T G2 saves costs by minimizing energy losses with its double conversion efficiency of up to 95 percent

High reliability

- Double conversion topology protects the load from all input disturbances
- Parallelable up to three units (6-10 kVA only) to provide system redundancy
- User-replaceable batteries
- Wide input voltage tolerance

Low cost of ownership

- Scalable runtime
- High operating efficiency
- Low installation and upgrading costs
- Compact design
- Output power factor of 1.0 (6-10 kVA only)

(up to 98 percent in ECO mode). Two or three units can be connected in parallel to boost power delivery to a maximum of 30 kW or to provide redundancy.

Simple to install or maintain, inexpensive to run and with the most compact online UPS footprint available on the market, the PowerValue 11T G2 provides stable, regulated, transient-free, pure sine wave AC power with extremely tight output voltage regulation. All units can be fitted with up to four external battery modules (EBMs) to extend runtime to well over two hours. Each EBM is dedicated to its corresponding UPS and setup is easily accomplished via the LCD menu.

Flexible design

- Multiple connectivity options
- Each UPS can be connected with up to four parallel battery modules for extended runtime
- Adjustable DC voltage and battery charger current
- Extended backup time models available
- Best power density available in the market segment

Efficient service concept

- Integrated manually operated maintenance bypass switch (6-10 kVA only)
- Easy setup and maintenance (plug and play)
- User-friendly display
- Remote monitoring options

PowerValue 11T G2 1-10 kVA

Product features

The PowerValue 11T G2 with its cost-effective ABB UPS technology makes a high-performance and is now available to market sectors with lower power requirements: Small server rooms, critical lab or industrial equipment, security installations and applications of a similar power class can now profit from one of 12 PowerValue 11T G2 models.

With the most compact online UPS footprint available, the PowerValue 11T G2 features true on-line double conversion. This provides a flexible output frequency and isolates the UPS from upstream disturbances so that the critical load sees only stable, well-regulated, transient-free, pure sine wave AC power.

A rated output power factor up to 1.0 (kVA = kW) means the PowerValue 11T G2 delivers 11 percent more active power than a UPS with a power factor of 0.9. The UPS is optimized for modern IT loads and helps users reduce their energy budget

with its double conversion efficiency of up to 95 percent (up to 98% in ECO mode).

- Low input line disturbances: input PF \geq 0.995 @ 100 percent linear load – THDi < 3 percent
- Flexible configuration for scalable runtime: UPS and EBMs with and without batteries (long backup)
- Adjustable DC voltage and battery charger current
- Digital charger technology provides accurate charger current setting and reduces charger ripple current
- The UPS is delivered with an inbuilt parallel board and paralleling cables. No additional hardware is required for this installation.

All this with the same guaranteed high availability and quality standards as ABB's higher-power premium UPS models - and at the most attractive entry level price around.

UPS configuration

Standard

- Tower-type, IP20 UPS enclosure
- Single-phase in and out
- Online double conversion UPS
- Paralleling up to three units allows for increase of capacity to 30 kW or redundancy (6-10 kVA only)
- Operator and status LCD
- Wide voltage input frequency range
- Inbuilt batteries (B/B2 versions only)
- Maintenance bypass switch (6-10 kVA only)
- Plug-and-play

Options

- Additional battery cabinets (EBM) for scaling autonomy time
- SNMP, ModBus and AS400 interface cards for remote control and monitoring of the UPS via a web browser
- Sensors – combined with the network interface card, environmental humidity and temperature sensors can be integrated into the system and monitored remotely
- Connectivity functionality via Winpower SNMP (network management card), mini SNMP, ModBus, mini ModBus, EMP (environmental monitoring probe), AS400 and mini AS400



PowerValue 11T G2 1-10 kVA

Available models

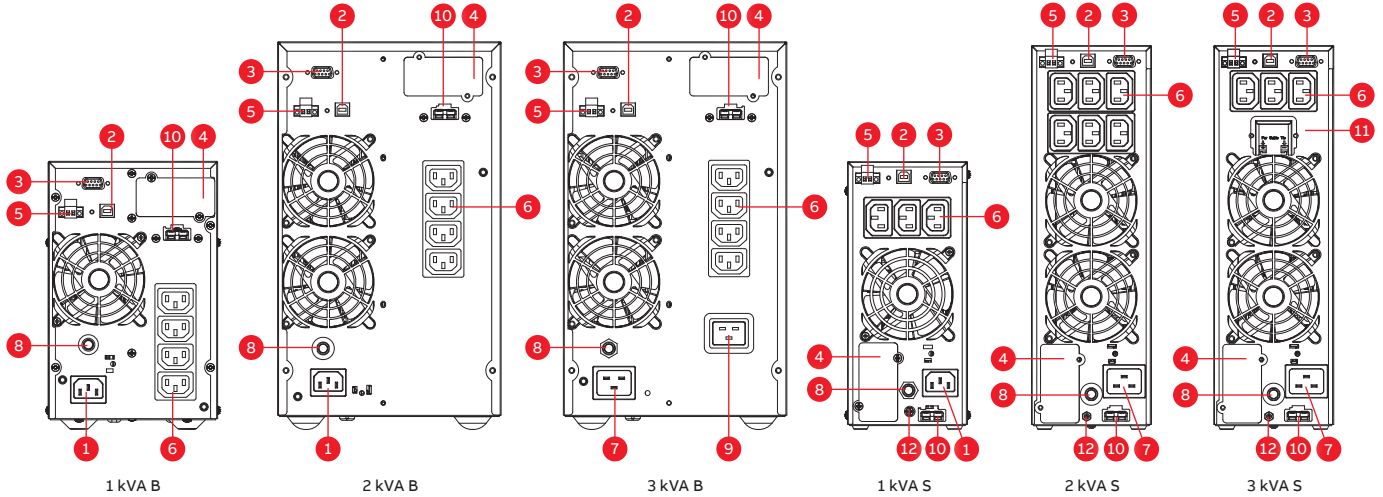

1. AC input 10 A	4. Mini SNMP/ Mini ModBus / Mini AS400	7. AC input 16 A	10. EBM connector
2. USB port	5. EPO / dry input	8. Output breaker	11. AC input 20 A
3. RS-232	6. AC output 10 A	9. AC output 16 A	12. GND contact

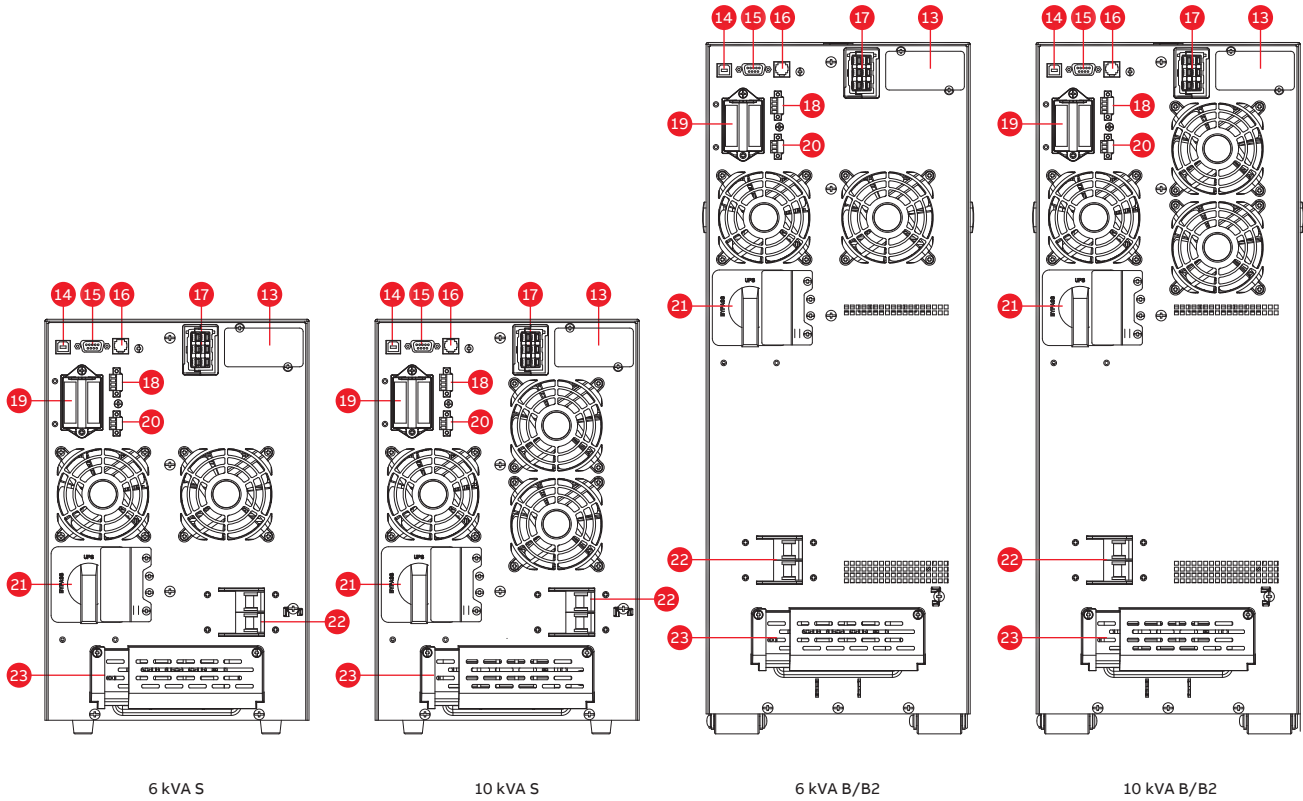

13. SNMP/ModBus/AS400	16. Reserved for future use	19. Parallel port	22. Input breaker
14. USB port	17. EBM connector	20. EPO	23. I/O terminals
15. RS-232	18. Dry in / out	21. MBP switch	

PowerValue 11T G2 1-10 kVA

Technical specifications

GENERAL DATA	G2 1kVA B/ S	G2 2kVA B/ S	G2 3kVA B/ S	G2 6kVA B/ B2 / S	G2 10kVA B/ B2 / S
Output rated power	900 W	1'800W	2'700W	6'000W	10'000W
Output power factor	0.9	0.9	0.9	1.0	1.0
Topology	Online double conversion				
Parallel configuration	No	No	No	Yes, up to 3 UPS	Yes, up to 3 UPS
Inbuilt batteries	Yes/No	Yes/No	Yes/No	Yes/Yes/No	Yes/Yes/No
INPUT					
Nominal input voltage	220/230/240 VAC			208/220/230/240 VAC	
Input voltage tolerance	100-300 VAC (load dependent)			100-276 (load dependent)	
Input current THDi	5% with full resistive load			<3% with full resistive load	
Frequency range	45-55 Hz / 54-66 Hz			45-55Hz / 54-66Hz (extendable to 40~70HZ at load < 60%)	
Power factor	≥0.99			≥0.995	
OUTPUT					
Rated output voltage	220/230/240 VAC			208/220/230/240 VAC	
Voltage tolerance	±1% (referred to 230V)				
Voltage distortion	<2% linear load, <6% non linear load			<1% linear load, <5% non linear load	
Overload capacity (linear load) on inverter	60s: 106-130% load 10s: 131-150% load 300ms: ≥ 150% load			10m: 102-125% load 30s: 126 to 150% load 500 ms: ≥ 150% load	
Nominal frequency	50 or 60 Hz				
Crest factor	3:1 (load supported)				
EFFICIENCY					
Overall system efficiency	Up to 89%	Up to 91%	Up to 91%	Up to 95%	
In eco-mode	Up to 97.5%	Up to 98%	Up to 98%	Up to 98%	
ENVIRONMENT					
Protection rating	IP20				
Storage temperature	UPS: -25°C to 60°C; Batteries: 0°C to 35°C				
Operating temperature	0°C to 40°C			0°-40°C (up to 50°C at 50% load)	
Relative humidity	0% to 95%				
Altitude (above sea level)	1000m without derating				
BATTERIES					
Type	VRLA (valve regulated lead-acid)				
Inbuilt batteries	2x9.4 Ah (B)	4x9.4Ah(B)	6x9.4Ah(B)	16x9Ah(B) 20x9Ah (B2)	16x9Ah(B) 20x9Ah (B2)
Charging current	1.5A/3-6A adjustable	1.5A/1.5-6A adjustable	1.5A/1.5-6A adjustable	0-4A adjustable (B,B2) 0-12 adjustable (S)	
Recharge time (inbuilt batteries)	4h to 90%				
COMMUNICATIONS					
User interface	LCD display				
Optional communication cards	SNMP;ModBus;AS400;Environmental monitoring sensor probe				
STANDARDS					
Safety	IEC/EN 62040-1				
EMC	IEC/EN 62040-2				
Performance	IEC/EN 62040-3				
Manufacturing	ISO 9001:2015, ISO 14001:2015, OHSAS 18001				
WEIGHT, DIMENSIONS					
Weight	9.2/3.9 Kg	17.4/6.4 Kg	22.7/6.4 Kg	61/73/13 Kg	55.2/65.2/15.2 Kg
Dimensions w x h x d	144x228x356 mm 102x228x346mm	190x327x399 mm 102x327x390 mm	190x327x399 mm 102x327x390 mm	B / B2: 225 x 589x 452 mm S: 225x 348 x 452 mm	B / B2: 225 x 589x 452 mm S: 225x 348 x 452 mm

PowerValue 11T G2 1-10 kVA

Ordering info table

UPS	External battery module (EBM)	Article number	Power (VA/W)	Typical runtime (min)	Dimensions WxHxD (mm)	Weight (kg)
PowerValue 11T G2 1kVA B		4NWP100160R0001	1000/900	13.5	144x228x356	9.3
+	EBM 11T G2 1kVA	4NWP100165R0001	1000/900	65	144x228x356 / pc	18.4 / pc
+	2xEBM 11T G2 1kVA	2x4NWP100165R0001	1000/900	130		
+	3xEBM 11T G2 1kVA	3x4NWP100165R0001	1000/900	200		
+	4xEBM 11T G2 1kVA	4x4NWP100165R0001	1000/900	275		
PowerValue 11T G2 2kVA B		4NWP100161R0001	2000/1800	14	190x327x399	17.2
+	EBM 11T G2 2kVA	4NWP100166R0001	2000/1800	68	190x327x399 / pc	36.2 / pc
+	2xEBM 11T G2 2kVA	2x4NWP100166R0001	2000/1800	135		
+	3xEBM 11T G2 2kVA	3x4NWP100166R0001	2000/1800	210		
+	4xEBM 11T G2 2kVA	4x4NWP100166R0001	2000/1800	290		
PowerValue 11T G2 3kVA B		4NWP100162R0001	3000/2700	14	190x327x399	22.2
+	EBM 11T G2 3kVA	4NWP100167R0001	3000/2700	45	190x327x399 / pc	36.2 / pc
+	2xEBM 11T G2 3kVA	2x4NWP100167R0001	3000/2700	90		
+	3xEBM 11T G2 3kVA	3x4NWP100167R0001	3000/2700	135		
+	4xEBM 11T G2 3kVA	4x4NWP100167R0001	3000/2700	185	190x327x399 / pc	36.2 / pc
PowerValue 11T G2 6kVA B		4NWP100163R0001	6000/6000	14	225x589x452	61.2
+	EBM 11T G2 6-10kVA (16x9)	4NWP100168R0001	6000/6000	64	225x589x452 / pc	95.2 / pc
+	2xEBM 11T G2 6-10kVA (16x9)	2x4NWP100168R0001	6000/6000	129		
+	3xEBM 11T G2 6-10kVA (16x9)	3x4NWP100168R0001	6000/6000	204		
+	4xEBM 11T G2 6-10kVA (16x9)	4x4NWP100168R0001	6000/6000	237		
PowerValue 11T G2 6kVA B2		4NWP100163R0002	6000/6000	19	225x589x452	72.4
+	EBM 11T G2 6-10kVA (20x9)	4NWP100168R0002	6000/6000	87	225x589x452	115.6 / pc
+	2xEBM 11T G2 6-10kVA (20x9)	2x4NWP100168R0002	6000/6000	175		
+	3xEBM 11T G2 6-10kVA (20x9)	3x4NWP100168R0002	6000/6000	276		
+	4xEBM 11T G2 6-10kVA (20x9)	4x4NWP100168R0002	6000/6000	390		
PowerValue 11T G2 10kVA B		4NWP100164R0001	10000/10000	7	225x589x452	60.9
+	EBM 11T G2 6-10kVA (16x9)	4NWP100168R0001	10000/10000	31	225x589x452 / pc	95.2 / pc
+	2x EBM 11T G2 6-10kVA (16x9)	2x4NWP100168R0001	10000/10000	64	225x589x452 / pc	95.2 / pc
+	3x EBM 11T G2 6-10kVA (16x9)	3x4NWP100168R0001	10000/10000	101		
+	4x EBM 11T G2 6-10kVA (16x9)	4x4NWP100168R0001	10000/10000	143		
PowerValue 11T G2 10kVA B2		4NWP100164R0002	10000/10000	9	225x589x452	70.9
+	EBM 11T G2 6-10kVA (20x9)	4NWP100168R0002	10000/10000	43	225x589x452	115.6 / pc
+	2xEBM 11T G2 6-10kVA (20x9)	2x4NWP100168R0002	10000/10000	87		
+	3xEBM 11T G2 6-10kVA (20x9)	3x4NWP100168R0002	10000/10000	137		
+	4xEBM 11T G2 6-10kVA (20x9)	4x4NWP100168R0002	10000/10000	194		

Table 1: Ordering info (UPS with internal batteries)

UPS	External battery module (EBM)	Article number	Power (VA/W)	Typical runtime (min)	Dimensions WxHxD (mm)	Weight (kg)
PowerValue 11T G2 1kVA S		4NWP100160R0002	1000/900		102x228x346	3.8
+	EBM 11T G2 1kVA	4NWP100165R0001	1000/900	48	144x228x356 / pc	18.4 / pc
+	2xEBM 11T G2 1kVA	2x4NWP100165R0001	1000/900	100		
+	3xEBM 11T G2 1kVA	3x4NWP100165R0001	1000/900	155		
+	4xEBM 11T G2 1kVA	4x4NWP100165R0001	1000/900	195		
PowerValue 11T G2 2kVA S		4NWP100161R0002	2000/1800		102x327x390	6.0
+	EBM 11T G2 2kVA	4NWP100166R0001	2000/1800	48	190x327x399 / pc	36.2 / pc
+	2xEBM 11T G2 2kVA	2x4NWP100166R0001	2000/1800	110		
+	3xEBM 11T G2 2kVA	3x4NWP100166R0001	2000/1800	165		
+	4xEBM 11T G2 2kVA	4x4NWP100166R0001	2000/1800	210		
PowerValue 11T G2 3kVA S		4NWP100162R0002	3000/2700		102x327x390	6.0
+	EBM 11T G2 3kVA	4NWP100167R0001	3000/2700	28	190x327x399 / pc	36.2 / pc
+	2xEBM 11T G2 3kVA	2x4NWP100167R0001	3000/2700	70		
+	3xEBM 11T G2 3kVA	3x4NWP100167R0001	3000/2700	110		
+	4xEBM 11T G2 3kVA	4x4NWP100167R0001	3000/2700	140		
PowerValue 11T G2 6kVA S		4NWP100163R0003	6000/6000		225x352x452	14.0
+	EBM 11T G2 6-10kVA (20x9)	4NWP100168R0002	6000/6000	49	225x589x452	115.6 / pc
+	2xEBM 11T G2 6-10kVA (20x9)	2x4NWP100168R0002	6000/6000	133		
+	3xEBM 11T G2 6-10kVA (20x9)	3x4NWP100168R0002	6000/6000	237		
+	4xEBM 11T G2 6-10kVA (20x9)	4x4NWP100168R0002	6000/6000	358		
PowerValue 11T G2 10kVA S		4NWP100164R0003	10000/10000		225x352x452	16
+	EBM 11T G2 6-10kVA (20x9)	4NWP100168R0002	6000/6000	23	225x589x452	115.6 / pc
+	2xEBM 11T G2 6-10kVA (20x9)	2x4NWP100168R0002	6000/6000	64		
+	3xEBM 11T G2 6-10kVA (20x9)	3x4NWP100168R0002	6000/6000	114		
+	4xEBM 11T G2 6-10kVA (20x9)	4x4NWP100168R0002	6000/6000	172		

Table 2: Ordering info (UPS with enhanced battery charger)

6 PowerValue 11 RT G2 1-10 kVA IEC

The single-phase UPS for critical applications



ABB's PowerValue 11 RT G2 is a double-conversion online UPS that guarantees up to 10 kW of clean, reliable power for your critical single-phase applications. As well as maintaining power to your servers, point-of-sale terminals, workstation clusters, routers, switches, hubs and sensitive electronic equipment, the PowerValue 11 RT G2 also conditions incoming power to eliminate spikes, swells, sags, noise and harmonics.

The PowerValue 11 RT G2 can be used as a standalone UPS device or installed into a standard 19" rack configuration, with connectivity options available for each.

Three units of the 6 or 10 kW models can be configured in parallel to provide redundancy or to increase the system's total capacity up to 30 kW. All units can be fitted with up to nine battery modules to extend runtime.

High reliability

- Reliable double conversion topology protects load from all input disturbances
- Batteries can be added or replaced easily
- Reduced recovery time from discharge
- Redundant parallel operation available (6 and 10 kW units)

Low cost of ownership

- Unity power factor (kW = kVA)
- Scalable runtime
- High operating efficiency, regardless of loading
- Reduced installation and upgrading costs
- Compact design

Flexible design

- Configurable in tower or rack-mount format
- Rotatable display
- UPS can be connected with up to nine external battery modules (EBMs) for extended runtime
- Long backup models available
- Full set of accessories and connectivity options

Efficient service concept

- Manually operated maintenance bypass switch (optional)
- Easy set-up and maintenance (plug-and-play)
- User-friendly display
- Hot-swap user-replaceable internal batteries

PowerValue 11 RT G2

Product features

Scalable solution

The advanced system architecture guarantees that the user is able to select a system to match their needs. Scalable runtime and the easy introduction of additional batteries make the solution sustainable.

In addition, three PowerValue 11 RT G2 6 or 10 kW UPSs can be connected in parallel to increase total power or to add redundancy. The UPSs are delivered with an installed parallel board and paralleling cables. No additional hardware is required for a parallel installation.

Easy installation and maintenance

Ease of installation and operation is guaranteed. The 1-3 kVA module is a plug-n-play device where all you need to do is to plug it in a wall socket to begin protection. The 6-10 kVA UPS only requires basic electronic competence to properly start up the unit.

Both models have a versatile orientation (rack or tower), just by rotating the display; for 1-3 kVA UPS this is as easy as pushing a button. Mechanical accessories for securing the installation in standard 19" racks or in a vertical position are included in each UPS.

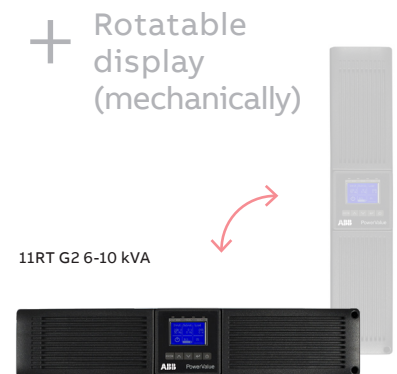
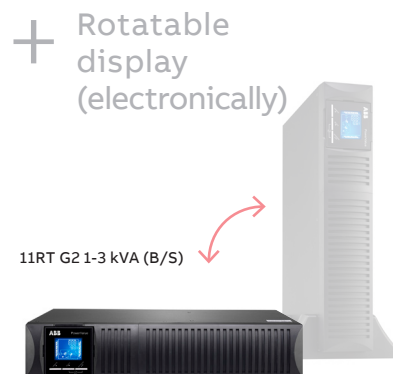

Complete product offering

PowerValue 11RT G2 comes as a complete offering. For the range 1-3 kVA, B and S models are available. B models include internal batteries for basic runtime applications; however external battery modules (EBMs) can be plugged in to extend the system backup. S models have no internal batteries but a more powerful battery charger to support runtime-demanding applications; up to nine external battery modules (EBMs) or third-party battery packs (adapter included in the UPS) can be connected to form a personalized battery capacity.

The 6-10 kVA UPS integrates a max 12 A battery charger to withstand the most demanding scenarios and to support high-capacity battery extensions. A comprehensive set of accessories and options is available, too: External battery modules (EBMs), external maintenance bypass with PDU, 1U automatic transfer switch (ATS), rail kits for rack mounting, relay card with additional I/O potential-free contacts and full connectivity suite are available to complete the installation. Finally, optional yearly warranty extensions to the comprehensive basic warranty of three years allow peace of mind throughout the whole life cycle of the UPS

PowerValue 11 RT G2

Available models

1	AC input 10 A
2	USB port
3	RS-232
4	SNMP / AS400 slot
5	EPO / dry contact input port
6	Dry contact output port
7	AC output 10A
8	AC input 16A
9	AC input 20 A
10	AC output 16A
11	EPO
12	Parallel port
13	Dry in / out
14	MBP connector
15	Output breaker
16	I/O terminals
17	Input breaker
18	EBM connector

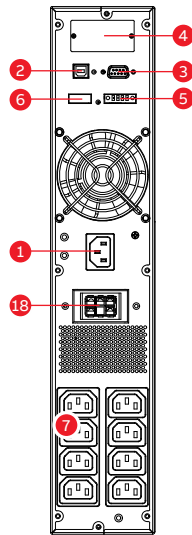

PowerValue
11RT G2 1 kVA B/S

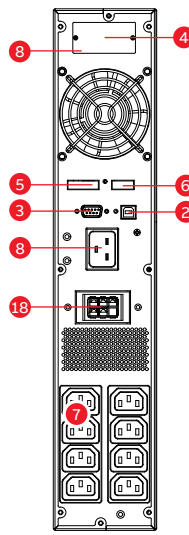

PowerValue
11RT G2 - 2 kVA B/S

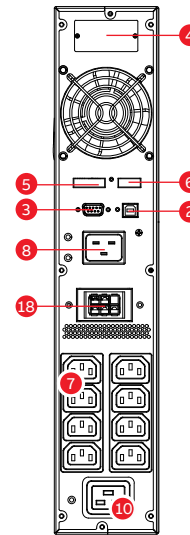

PowerValue
11RT G2 - 3 kVA B

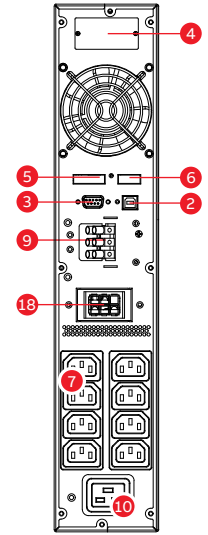

PowerValue
11RT G2 - 3 kVA S

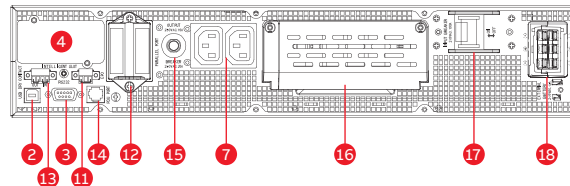

PowerValue 11RT G2 - 6-10 kVA

Options

- Rack installation kit allows for easy mounting in standard 19" rack
- Full-range connectivity: SNMP, ModBus (RS-485 and TCP/IP), environmental monitoring probe, relay card with I/O contacts
- External maintenance bypass
- 1U automatic transfer switch (ATS) (PowerValue 11RT G2 1-3 kVA)
- High capacity external battery modules (EBMs) to scale up the system runtime (a plug-and-play cable included to connect UPS and other battery modules)

UPS configuration

- Online double conversion UPS
- Unity power factor (kW = kVA)
- Efficiency in online mode up to 95%
- Efficiency in eco-mode up to 98%
- Configurable in tower format or rack-mount
- Three 6 kVA and 10 kVA UPSs (max 30 kW per system) can be connected in parallel for redundancy or extra capacity
- Cold start
- Frequency-converter operation (50 Hz or 60 Hz)
- Interfaces: USB, RS-232, potential-free contacts, EPO
- Load segmentation (for PowerValue 11RT G2 1-3 kVA)

PowerValue 11 RT G2

Technical specification

GENERAL DATA	1kW B/ S	2kW B/ S	3kW B/ S	6 kW	10 kW
Output rated power	1,000 W	2,000 W	3,000 W	6,000 W	10,000 W
Output power factor	1.0	1.0	1.0	1.0	1.0
Topology	Online double conversion				
Parallel configuration	No	No	No	Yes, up to 3 UPS	Yes, up to 3 UPS
Inbuilt batteries	Yes/No	Yes/No	Yes/No	No	No
INPUT					
Nominal input voltage	208/220/230/240 VAC				
Input voltage tolerance	120-300 VAC (load dependent)			100-276 (load dependent)	
Input current THDi	<5 % with full resistive load			<3 % with full resistive load	
Frequency range	45-55 Hz / 54-66 Hz			45-55 Hz / 54-66 Hz (extendable to 40~70 HZ at load < 60 %)	
Power factor	≥0.99			≥0.995	
OUTPUT					
Rated output voltage	208/220/230/240 VAC				
Voltage tolerance	±1 % (referred to 230V)				
Voltage distortion	< 2 % linear load, <5 % non-linear load			<1 % linear load, <5 % non-linear load	
Overload capacity (linear load) on inverter	60 s: 102-129 % load 10 s: 130-150 % load 300 ms: ≥ 150 % load			10 m: 102-125 % load 30 s: 126 to 150 % load 500 ms: ≥ 150 % load	
Nominal frequency	50 or 60 Hz				
Crest factor	3:1 (load supported)				
EFFICIENCY					
Overall system efficiency	Up to 92 %			Up to 95 %	
In eco-mode	Up to 98 %			Up to 98 %	
ENVIRONMENT					
Protection rating	IP20				
Storage temperature	UPS: -25 °C to 60 °C; batteries: 0 °C to 35 °C				
Operating temperature	0 °C to 40 °C				
Relative humidity	0 % to 95 %				
Altitude (above sea level)	1000 m without derating				
BATTERIES					
Type	VRLA (valve regulated lead-acid)				
Inbuilt batteries	2x9.4 Ah	4x9.4 Ah	6x9.4 Ah	-	-
Max charging current	1.5 A/6 A	1.5 A/6 A	1.5 A/6 A	0-12 A adjustable	
COMMUNICATIONS					
User interface	LCD				
Optional communication cards	SNMP; ModBus; AS400; Environmental monitoring sensor probe				
STANDARDS					
Safety	IEC/EN 62040-1				
EMC	IEC/EN 62040-2				
Performance	IEC/EN 62040-3				
Manufacturing	ISO 9001:2015, ISO 14001:2015, OHSAS 18001				
WEIGHT, DIMENSIONS					
Weight	11.4/5.8 kg	18.1/8.7 kg	27.9/9 kg	13.6 kg	15.5 kg
Dimensions w x h x d	438x86(2U) x309 mm	438x86(2U) x426 mm	438x86(2U) x629 mm	438x86(2U) x573 mm	438x86(2U) x573 mm

PowerValue 11RT G2

Ordering info table

UPS	External battery module (EBM)	Article number	Power (VA/W)	Typical runtime (min)	Dimensions WxHxD (mm)	Weight (kg)
PowerValue 11RT G2 1 kVA B		4NWP100200R0001	1000/1000	13'	438x86 (2RU)x309	11.4
+	EBM 11RT G2 1 kVA	4NWP100203R0001	1000/1000	49'	438x86 (2RU)x309/pc	17.9/pc
+	2xEBM 11RT G2 1 kVA	2x4NWP100203R0001	1000/1000	89'		
+	3xEBM 11RT G2 1 kVA	3x4NWP100203R0001	1000/1000	128'		
+	4xEBM 11RT G2 1 kVA	4x4NWP100203R0001	1000/1000	170'		
PowerValue 11RT G2 2 kVA B		4NWP100201R0001	2000/2000	13'	438x86 (2RU)x426.5	19.1
+	EBM 11RT G2 2 kVA	4NWP100204R0001	2000/2000	50'	438x86 (2RU)x426.5	31.3/pc
+	2xEBM 11RT G2 2 kVA	2x4NWP100204R0001	2000/2000	90'		
+	3xEBM 11RT G2 2 kVA	3x4NWP100204R0001	2000/2000	131'		
+	4xEBM 11RT G2 2 kVA	4x4NWP100204R0001	2000/2000	172'		
PowerValue 11RT G2 3 kVA B		4NWP100202R0001	3000/3000	13'	438x86 (2RU)x629	27.9
+	EBM 11RT G2 3 kVA	4NWP100205R0001	3000/3000	51'	438x86 (2RU)x629	44.9/pc
+	2xEBM 11RT G2 3 kVA	2x4NWP100205R0001	3000/3000	91'		
+	3xEBM 11RT G2 3 kVA	3x4NWP100205R0001	3000/3000	133'		
+	4xEBM 11RT G2 3 kVA	4x4NWP100205R0001	3000/3000	173'		

Table 3: Ordering info (UPS with internal batteries)

UPS	External battery module (EBM)	Article number	Power (VA/W)	Typical runtime (min)	Dimensions WxHxD (mm)	Weight (kg)
PowerValue 11RT G2 1 kVA S		4NWP100200R0007	1000/1000	-	438x86 (2RU)x309	5.8
+	EBM 11RT G2 1 kVA	4NWP100203R0001	1000/1000	29'	438x86 (2RU)x309/pc	17.9/pc
+	2xEBM 11RT G2 1 kVA	2x4NWP100203R0001	1000/1000	71'		
+	3xEBM 11RT G2 1 kVA	3x4NWP100203R0001	1000/1000	109'		
+	4xEBM 11RT G2 1 kVA	4x4NWP100203R0001	1000/1000	152'		
PowerValue 11RT G2 2 kVA S		4NWP100201R0007	2000/2000	-	438x86 (2RU)x426.5	8.7
+	EBM 11RT G2 2 kVA	4NWP100204R0001	2000/2000	30'	438x86 (2RU)x426.5	31.3/pc
+	2xEBM 11RT G2 2 kVA	2x4NWP100204R0001	2000/2000	72'		
+	3xEBM 11RT G2 2 kVA	3x4NWP100204R0001	2000/2000	110'		
+	4xEBM 11RT G2 2 kVA	4x4NWP100204R0001	2000/2000	154'		
PowerValue 11RT G2 3 kVA S		4NWP100202R0007	3000/3000	-	438x86 (2RU)x629	9
+	EBM 11RT G2 3 kVA	4NWP100205R0001	3000/3000	31'	438x86 (2RU)x629	44.9/pc
+	2xEBM 11RT G2 3 kVA	2x4NWP100205R0001	3000/3000	73'		
+	3xEBM 11RT G2 3 kVA	3x4NWP100205R0001	3000/3000	111'		
+	4xEBM 11RT G2 3 kVA	4x4NWP100205R0001	3000/3000	155'		

Table 4: Ordering info (UPS with enhanced battery charger)

7 PowerValue 11 / 31 T

The single-phase UPS for IT rooms, networks and other critical applications

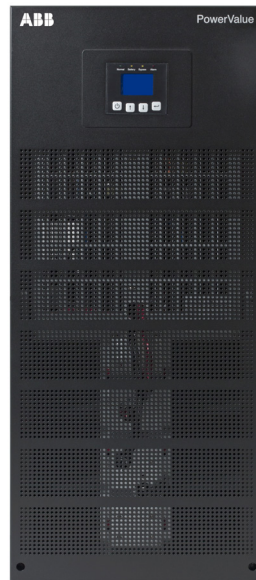

The PowerValue 11/31 T UPS delivers reliable power, low running costs, long battery life, easy maintenance and high levels of flexibility. Featuring double-conversion, voltage and frequency independent (VFI) topology, the PowerValue 11/31 T is available in both 10 and 20 kVA versions, with the option to configure up to four units in parallel to boost power capability or provide redundancy.

High reliability

- Online double conversion topology
- Parallelable up to four units to provide system redundancy
- Programmed and automated battery tests ensure optimized battery management

Low cost of ownership

- Simple power increase by paralleling up to four units
- High operating efficiency, regardless of loading
- Reduced installation costs
- Compact design

Three-phase or single-phase inputs can also be accommodated, as well as single- or dual-supply inputs – allowing the customer to manage two independent power sources. Simple to install and with a small footprint, the PowerValue 11/31 T provides stable, regulated, transient-free, pure sine wave AC power with extremely tight output voltage regulation.

Flexible design

- Different autonomy variations with inbuilt batteries or additional battery cabinets
- Long backup models available
- Single- or three-phase input – adaptable to installation requirements (field configurable)
- Single- or dual-input power source compatible (field configurable)

Efficient service concept

- Integrated manual bypass switch
- Easy to install and maintain
- User-friendly display
- User-replaceable batteries
- Remote monitoring and connectivity options

PowerValue 11 / 31 T

Product features

Compact power protection up to 80 kVA

PowerValue 11/31T 10 and 20 kVA UPS can be installed in parallel to increase the total system power up to 80 kVA or to add redundancy to the system. The UPSs are delivered with an inbuilt parallel board and paralleling cables. No additional hardware is required for this installation.

PowerValue 11/31T can be configured with up to two matching battery cabinets to satisfy extended runtime demands. Easily accessible and replaceable batteries increase availability and reduce mean time to repair (MTTR).

Up to 4 UPSs
in parallel



Up to 2 battery
cabinets in parallel

Frequency conversion

Operating as a frequency converter, PowerValue 11/31T not only converts the power supply frequency (50 Hz to/from 60 Hz), but it also protects the load from power disturbances and guarantees additional battery power in case of mains failure.

The operation and installation is simple and consists merely of correctly wiring the UPS and selecting the frequency conversion mode in the LCD.

- Input frequency range: 40–70 Hz
- Output frequency: 50 Hz or 60 Hz
- Output derating:
 - Single-phase input: 60%
 - Three-phase input: no derating

PowerValue 11 / 31 T

Available models

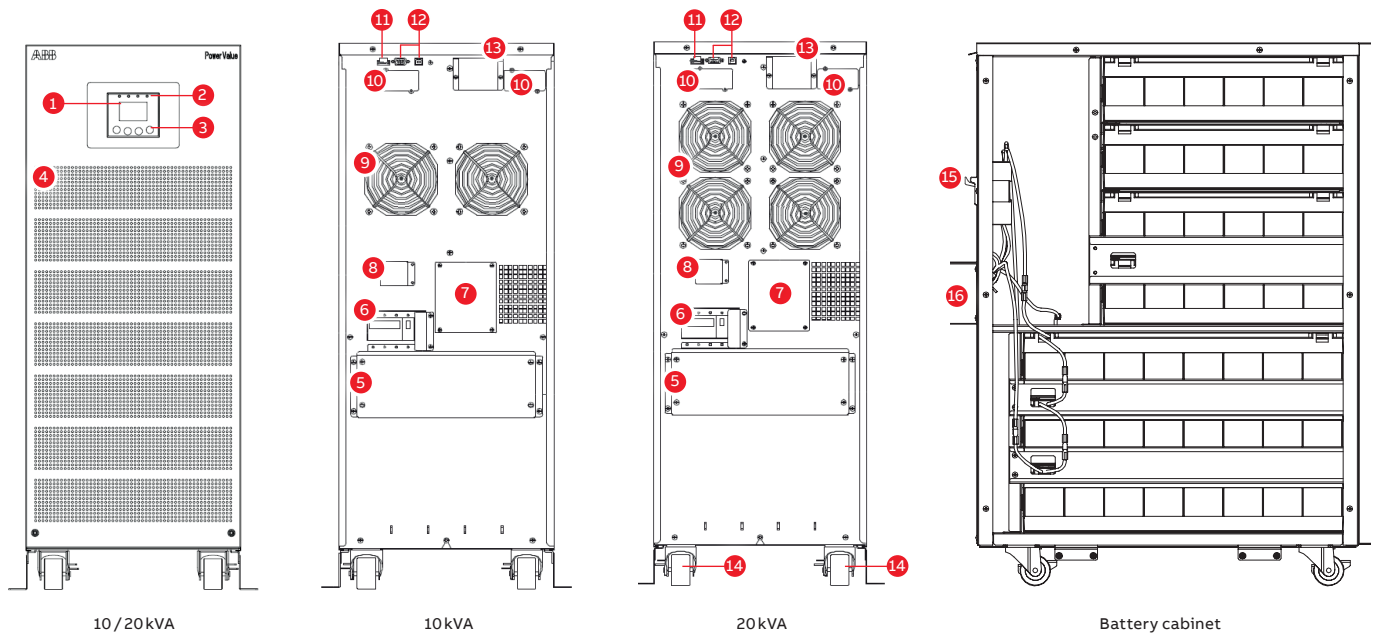

1 LCD	5 Connection terminals	9 Fans	13 Parallel port
2 LEDs	6 Input breaker	10 Network interface / AS400 slot	14 Wheels / support and brakes
3 Control keys	7 Manual bypass	11 EPO contact	15 Fuse holder
4 Ventilation inlets	8 Back-feed protection terminals	12 RS-232 port / USB port	16 Battery connection terminals

UPS cabinet configuration

- Online double conversion UPS
- Efficiency in online mode up to 93.9%
- Efficiency in eco-mode up to 97%
- Paralleling up to four units allows for increase of capacity or redundancy
- Same model supports different wiring schemes
- Three-phase and single-phase input
- Single- and dual-input feed
- LCD
- Frequency converter operation (50 Hz or 60 Hz)
- Interfaces: USB, RS-232, ModBus, potential-free contacts, EPO contact inputs
- Emergency power-off for remote shutdown

Options

- Dry-contact card – relay interface card enables advanced communication between the UPS systems
- Network interface cards – control and monitoring of the UPS via a web browser
- Sensors – combined with the network interface card, humidity and temperature sensors can be integrated into the system and monitored remotely
- Additional battery cabinets that match perfectly with the UPS for scaling autonomy time

PowerValue 11 / 31 T

Ordering info table

UPS	External battery module (EBM)	Article number	Power (VA/W)	Typical runtime (min)	Dimensions WxHxD (mm)	Weight (kg)
PowerValue 11/31 T 10kVA		4NWP100117R0001	10000/9000		350x1120x815	58
+	1xEBM 11/31T	4NWP100119R0003	10000/9000	69	350x1120x815 / pc	303 / pc (including batteries)
+	2xEBM 11/31T	2x4NWP100119R0003	10000/9000	151		
PowerValue 11/31 T 10kVA B		4NWP100117R0002	10000/9000		350x1120x815	118
+	1xEBM 11/31T	4NWP100119R0003	10000/9000	87	350x1120x815 / pc	303 / pc (including batteries)
+	2xEBM 11/31T	2x4NWP100119R0003	10000/9000	176		
PowerValue 11/31 T 10kVA B2		4NWP100117R0003	10000/9000		350x1120x815	178
+	1xEBM 11/31T	4NWP100119R0003	10000/9000	109	350x1120x815 / pc	303 / pc (including batteries)
+	2xEBM 11/31T	2x4NWP100119R0003	10000/9000	208		
PowerValue 11/31 T 20kVA		4NWP100118R0001	20000/18000		350x1120x815	67.5
+	1xEBM 11/31T	4NWP100119R0003	20000/18000	29	350x1120x815 / pc	303 / pc (including batteries)
+	2xEBM 11/31T	2x4NWP100119R0003	20000/18000	69		
PowerValue 11/31 T 20kVA B		4NWP100118R0002	20000/18000		350x1120x815	188
+	1xEBM 11/31T	4NWP100119R0003	20000/18000	49	350x1120x815 / pc	303 / pc (including batteries)
+	2xEBM 11/31T	2x4NWP100119R0003	20000/18000	97		

Table 5: Ordering info

UPS	External battery module (EBM)	Article number	Power (VA/W)	Typical runtime (min)	Dimensions WxHxD (mm)	Weight (kg)
PowerValue 11/31 T 10kVA S		4NWP100117R0004	10000/9000		350x1120x815	58
+	1xEBM 11/31T	4NWP100119R0003	10000/9000	69	350x1120x815 / pc	303 / pc (including batteries)
+	2xEBM 11/31T	2x4NWP100119R0003	10000/9000	151		
PowerValue 11/31 T 20kVA S		4NWP100118R0004	10000/9000		350x1120x815	67.5
+	1xEBM 11/31T	4NWP100119R0003	10000/9000	49	350x1120x815 / pc	303 / pc (including batteries)
+	2xEBM 11/31T	2x4NWP100119R0003	10000/9000	97		

Table 6: Ordering info (UPS with enhanced battery charger)

8 PowerScale 33 10-50 kVA

The three-phase UPS for low power applications

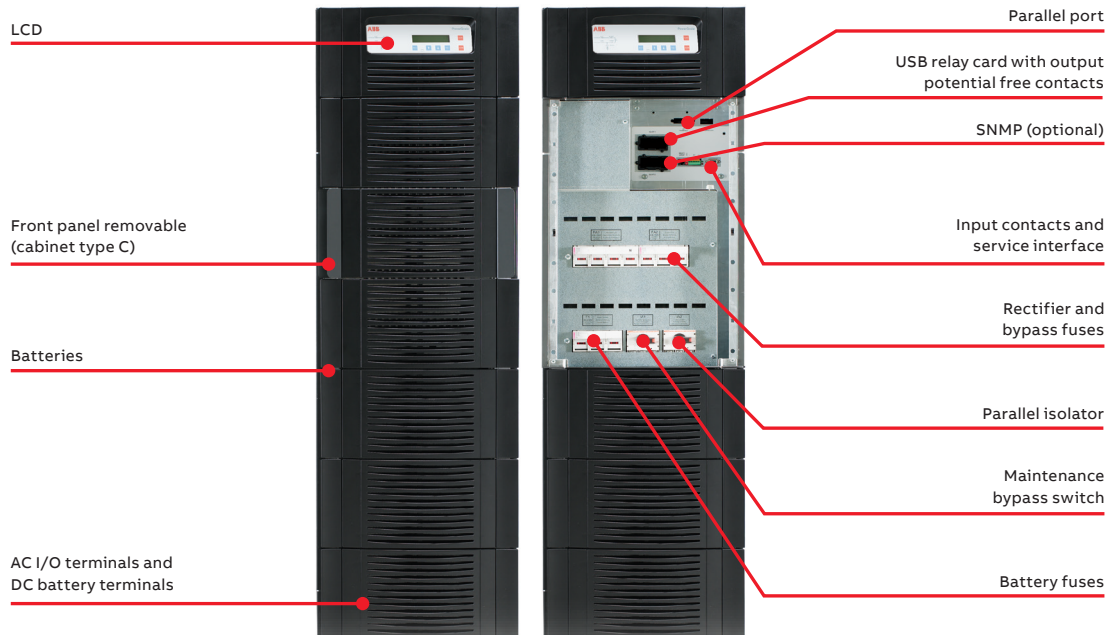

PowerScale is an online, double-conversion, VFI (voltage frequency independent) UPS that provides enhanced power protection in a compact format. Its outstanding price/performance delivers the best value for money in its category with

uncompromised system reliability and power availability. PowerScale is available in three cabinet sizes, enabling you to choose the ideal capacity and required autonomy for your critical load.

High reliability

- Online double conversion technology
- Parallelable systems for increased redundancy

Low cost of ownership

- Scalable power and autonomy time
- Small footprint/high power density
- High efficiency at partial and rated loads (up to 95.5%)
- Reduced installation costs
- Ripple-free and temperature controlled battery chargers extend battery life time performance
- Low input harmonic distortion (THDi <3%)

Flexible design

- Available in seven power ratings and three cabinet sizes
- Parallel capacity up to 20 units
- External battery cabinets for extended autonomy

Efficient service concept

- Manually operated maintenance bypass switch
- User-friendly LCD
- Ergonomic design for easy serviceability
- Remote monitoring and connectivity options

PowerScale 33 10-50 kVA

Available models

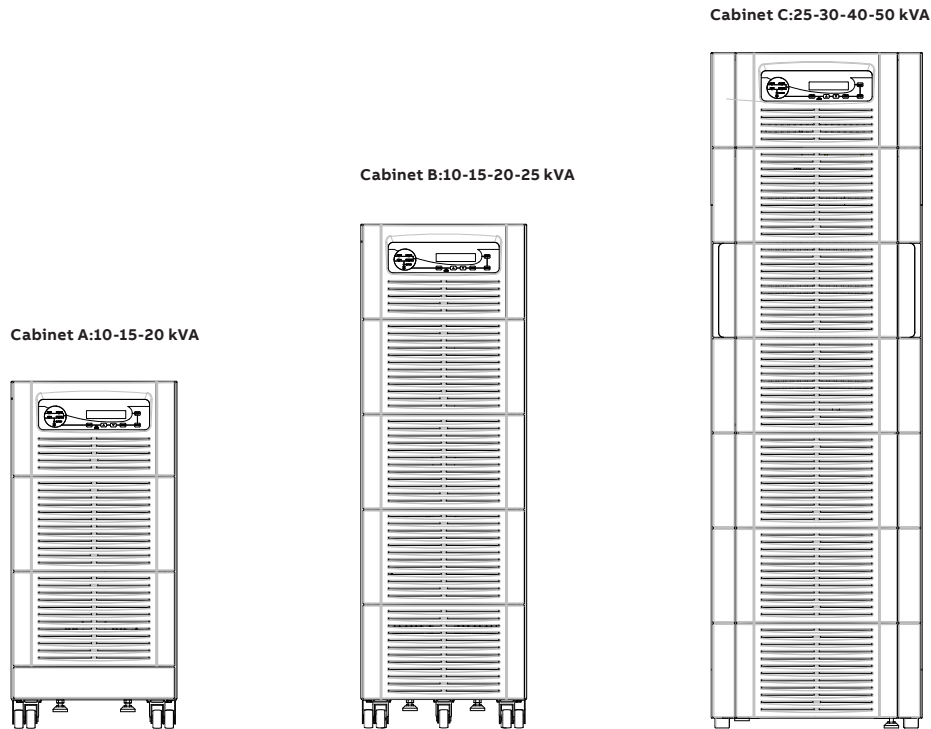

Standard configuration

- Online double conversion UPS
- Capacities from 10 kVA to 50 kVA in three different cabinet sizes
- Input, bypass and battery protection fuses
- Manual bypass switch
- Up to 95.5% efficiency across a wide load range
- Single- and dual-input feed available
- Integrated back-feed protection
- Communication interfaces: RS-232 and USB ports, input dry contacts (EPO, GEN On, ...)
- With or without internal batteries
- Parallel ready (up to 20 units)
- Relay card with USB and output potential free contacts

Options

- Battery temperature sensor
- External battery cabinets
- ModBus RS-485, ModBus TCP/IP, SNMP

Safeguarding your power supply has never been easier. Ideal for small and medium IT power environments, ABB's PowerScale three-phase UPS is simple and cost-effective to install, maintain and expand.

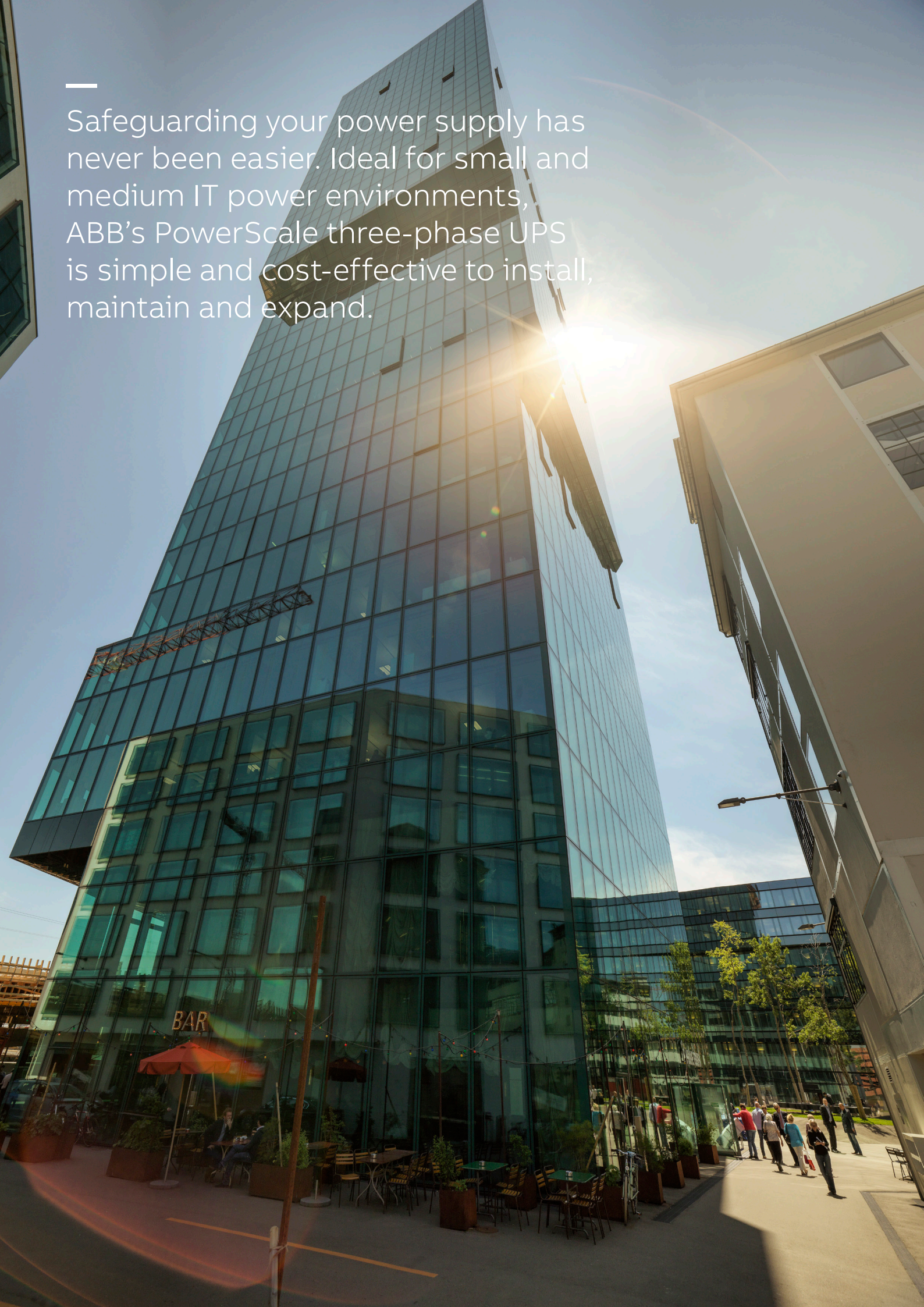

PowerScale 33 10-50 kVA

Technical specifications

General data	10kVA	15kVA	20kVA	25kVA	30kVA	40kVA	50kVA	
Output power max.	9kW	13.5kW	18kW	22.5kW	27 kW	36kW	45kW	
Output power factor								0.9
Topology								Online double conversion
Parallel configuration								Up to 20 units in parallel configuration
UPS type								Standalone
Inbuilt batteries								Yes (model dependent)
Input								
Nominal input voltage								3×380V/220V+N, 3×400V/230V+N, 3×415V/240V+N
Voltage tolerance (referred to ×400V/230V)								For loads <100% (-10%, +15%), <80% (-20%, +15%), <60% (-30%, +15%)
Input distortion THDi								≤3 at 100% (sine wave)
Frequency								35–70Hz
Power factor								0.99 at 100% load
Output								
Rated output voltage								3×380 V / 220 V + N, 3×400 V / 230 V + N, 3×415 V / 240 V + N
Voltage tolerance (referred to ×400V/230V)								1% (static), 4% (dynamic)
Voltage distortion								<2% linear load, <4% non linear load (IEC/EN62040-3)
Frequency								50 Hz or 60 Hz
Overload capability								5 min.:110 % or 20 sec.: 125 % (10 kVA - 25 kVA); 10 min.: 110 % or 1 min.: 125 % (30 kVA - 50 kVA)
Unbalanced load								100% (all three phases regulated independently)
Crest factor								3:1 (load supported)
Efficiency								
Overall efficiency								Up to 95.5%
In eco-mode configuration								98%
Environment								
Storage temperature								-25 °C to +70 °C
Operating temperature								0 °C to +40 °C
Altitude								1000m without derating
Battery								
Battery type								7 Ah / 8 Ah, sealed, lead-acid, maintenance-free, 6-9 years design lifetime
Battery replacement								Field-replaceable
Battery voltage								Flexible voltage for longer backup times
Max battery capacity	48 or 96×7/8Ah	48 or 96×7/8Ah	48 or 96×7/8Ah	96 or 144×7/8Ah	144×7/8 Ah	144×7/8Ah	144×7/8Ah	
Communications								
LCD								Yes (per module)
LEDs								LED for notification and alarm
Communication ports								RS-232, SNMP slot, USB and potential-free contacts
Standards								
Safety								IEC / EN 62040-1
Electromagnetic compatibility (EMC)								IEC / EN 62040-2
Performance								IEC / EN 62040-3
Product certification								CE
Protection rating								IP 20
Manufacturing								ISO 9001:2015, ISO 14001:2015, OHSAS18001
Weight, dimensions								
Cabinet type	A or B	A or B	A or B	B or C	C	C	C	
Weight	48 (cab A) - 68 (cab B)	48 (cab A) - 68 (cab B)	48 (cab A) - 68 (cab B)	68 (cab B) - 177 (cab C)	177 kg	177 kg	177 kg	
Dimensions w×h×d (mm)	345×720×710 or 345×1045×710	345×720×710 or 345×1045×710	345×720×710 or 345×1045×710	345×720×710 or 345×1045×710 or 440×1400×910	440×1400×910	440×1400×910	440×1400×910	

PowerScale 33 10-50 kVA

Ordering info table

UPS	External battery cabinet	Article number	Power (VA/W)	Batteries info	Typical runtime (min)	Dimensions WxHxD (mm)	Weight (kg)
UPS Powerscale 33 10kVA Cab.A w/o batt.		4NWP103584A1000	10000/9000			345x720x710	48
+	C-BATT88	4NWP103674BC088	10000/9000	2x44x28Ah	125	490x1400x940	1015*
UPS Powerscale 33 10kVA Cab.A 10 min		4NWP103584A1010	10000/9000	28x8Ah	10	345x720x710	118
UPS Powerscale 33 10kVA Cab.A 15 min		4NWP103584A1015	10000/9000	38x8Ah	15	345x720x710	143
UPS Powerscale 33 10kVA Cab.A 20 min		4NWP103584A1020	10000/9000	46x8Ah	20	345x720x710	163
UPS Powerscale 33 15kVA Cab.A w/o batt.		4NWP103584A1500	15000/13500			345x720x710	48
+	C-BATT88	4NWP103674BC088	15000/13500	2x44x28Ah	110	490x1400x940	1015*
UPS Powerscale 33 15kVA Cab.A 10 min		4NWP103584A1510	15000/13500	42x8Ah	10	345x720x710	153
UPS Powerscale 33 15kVA Cab.A 12 min		4NWP103584A1512	15000/13500	48x8Ah	12	345x720x710	168
UPS Powerscale 33 20kVA Cab.A w/o batt.		4NWP103584A2000	20000/18000			345x720x710	48
+	C-BATT88	4NWP103674BC088	20000/18000	2x44x28Ah	60	490x1400x940	1015*
UPS Powerscale 33 20kVA Cab.A 8 min		4NWP103584A2008	20000/18000	48x8Ah	8	345x720x710	168
UPS Powerscale 33 10kVA Cab.B w/o batt.		4NWP103584B1000	10000/9000			345x1045x710	68
+	C-BATT88	4NWP103674BC088	10000/9000	2x44x28Ah	125	490x1400x940	1015*
UPS Powerscale 33 10kVA Cab.B 30 min		4NWP103584B1030	10000/9000	2x32x8Ah	30	345x1045x710	228
UPS Powerscale 33 10kVA Cab.B 50 min		4NWP103584B1050	10000/9000	2x48x8Ah	50	345x1045x710	308
UPS Powerscale 33 15kVA Cab.B w/o batt.		4NWP103584B1500	15000/13500			345x1045x710	68
+	C-BATT88	4NWP103674BC088	15000/13500	2x44x28Ah	110	490x1400x940	1015*
UPS Powerscale 33 15kVA Cab.B 20 min		4NWP103584B1520	15000/13500	2x36x8Ah	20	345x1045x710	248
UPS Powerscale 33 15kVA Cab.B 30 min		4NWP103584B1530	15000/13500	2x46x8Ah	30	345x1045x710	298
UPS Powerscale 33 20kVA Cab.B w/o batt.		4NWP103584B2000	20000/180000			345x1045x710	68
+	C-BATT88	4NWP103674BC088	20000/180000	2x44x28Ah	60	490x1400x940	1015*
UPS Powerscale 33 20kVA Cab.B 20 min		4NWP103584B2020	20000/180000	2x44x8Ah	20	345x1045x710	288
UPS Powerscale 33 20kVA Cab.B 22 min		4NWP103584B2022	20000/180000	2x48x8Ah	22	345x1045x710	308
UPS Powerscale 33 25kVA Cab.B w/o batt.		4NWP103584B2500	25000/22500			345x1045x710	68
+	C-BATT88	4NWP103674BC088	25000/22500	2x44x28Ah	50	490x1400x940	1015*
UPS Powerscale 33 25kVA Cab.B 15 min		4NWP103584B2515	25000/22500	2x48x8Ah	15	345x1045x710	308

UPS	External battery cabinet	Article number	Power (VA/W)	Batteries info	Typical runtime (min)	Dimensions WxHxD (mm)	Weight (kg)
UPS Powerscale 33 25kVA Cab.C w/o batt.		4NWP103584C2500	25000/22500			440x1400x910	177
+	C-BATT88	4NWP103674BC088	25000/22500	2x44x28Ah	50	490x1400x940	1015*
UPS Powerscale 33 25kVA Cab.C 20 min		4NWP103584C2520	25000/22500	3x46x8Ah	20	440x1400x910	522
UPS Powerscale 33 30kVA Cab.C w/o batt.		4NWP103584C3000	30000/27000			440x1400x910	177
+	C-BATT88	4NWP103674BC088		2x44x28Ah	42	490x1400x940	1015*
UPS Powerscale 33 30kVA Cab.C 10 min		4NWP103584C3010	30000/27000	3x28x8Ah	10	440x1400x910	387
UPS Powerscale 33 30kVA Cab.C 15 min		4NWP103584C3015	30000/27000	3x36x8Ah	15	440x1400x910	447
UPS Powerscale 33 30kVA Cab.C 20 min		4NWP103584C3020	30000/27000	3x48x8Ah	20	440x1400x910	537
UPS Powerscale 33 40kVA Cab.C w/o batt.		4NWP103584C4000	40000/36000			440x1400x910	177
+	C-BATT88	4NWP103674BC088	40000/36000	2x44x28Ah	31	490x1400x940	1015*
UPS Powerscale 33 40kVA Cab.C 10 min		4NWP103584C4010	40000/36000	3x36x8Ah	10	440x1400x910	447
UPS Powerscale 33 40kVA Cab.C 15 min		4NWP103584C4015	40000/36000	3x48x8Ah	15	440x1400x910	537
UPS Powerscale 33 50kVA Cab.C w/o batt.		4NWP103584C5000	50000/45000			440x1400x910	177
+	C-BATT88	4NWP103674BC088	50000/45000	2x44x28Ah	21	490x1400x940	1015*
UPS Powerscale 33 50kVA Cab.C 10 min		4NWP103584C5010	50000/45000	3x46x8Ah	10	440x1400x910	522

* batteries included

Table 7: Ordering info

9 Accessories

Accessory compatibility matrix

UPS	Accessories													
	AS400 relay card	MiniAS400 relay card	WebPro SNMP	Winpower SNMP	Mini Winpower SNMP	WebPro ModBus	Winpower ModBus	Mini Winpower ModBus	Mini Winpower EMP	CS141 Basic	CS141 Advanced	CS141 ModBus	ATS-16	External maintenance bypass with PDU
PowerValue 11T G2 1-3 VA (B/S)		•			•			•	•					
PowerValue 11T G2 6-10 VA (B/S)	•			•			•		•	•	•	•		
PowerValue 11RT G2 1-3 VA (B/S)	•		•			•			•	•	•	•	•	•
PowerValue 11RT G2 6-10 VA (B/S)	•			•			•		•	•	•	•		•
PowerValue 11/31T 10-20 kVA	•			•			•		•	•	•	•		
PowerScale 33 10-50 kVA										•	•	•		

Table 8: Accessory compatibility matrix

PowerValue 11RT G2 1-3 kVA (B/S) can be connected via RS232 to a CS141 box version. The CS141 slot version can be connected to the UPS via RS232 with an external enclosure; please contact ABB for further information

9a Connectivity options

Smart power monitoring for single or multiple systems

ABB offers intelligent solutions that monitor the status of your power system and thus ensure your data storage equipment or control process continues to receive clean, reliable power. The monitoring devices provide real-time visibility of the condition of your power equipment and help to identify problematic trends before they become critical.

Power and environmental monitoring

Network interface cards connect ABB's UPS systems to the network. These cards also provide the ability to connect several environmental sensors to the UPS. This combination allows for a clear visual representation on a web interface of not only the UPS system but also its environment.

Management software

The network interface cards are provided with extensively configurable software that provide access to measurement values and to the UPS's status information. The status of each UPS cabinet, UPS module or the entire system can be presented on a separate mimic diagram. These diagrams provide users with clear, real-time information. During normal operation, records of all events are kept in a log file. In case of a power failure, battery autonomy is monitored and network shutdown of the protected devices is initiated.

Data protection

The remote shutdown software manages a particular workstation, network or servers. Shutdown or reboot can be executed safely.

In addition, text messages, e-mails, pop-ups and mobile messages can be dispatched or displayed before the devices are shut down – giving the user the flexibility to manage or cancel the operation.

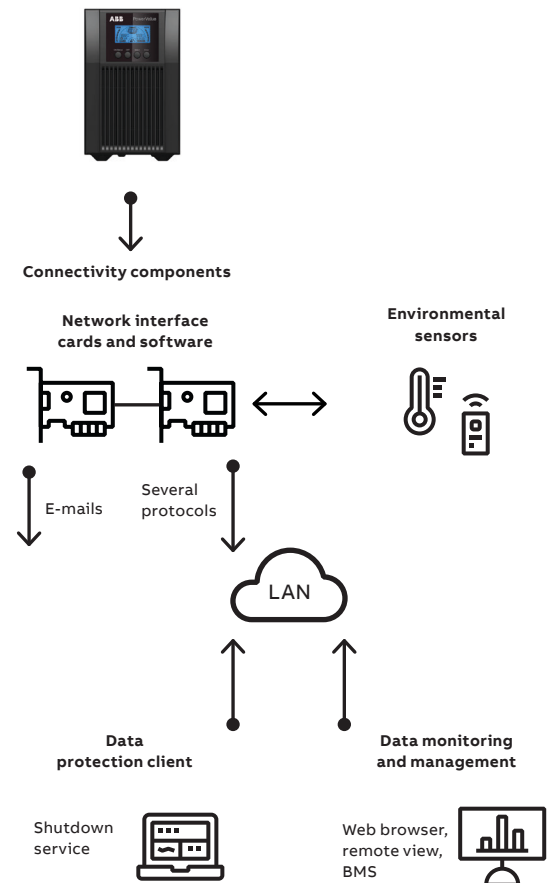

Highlights

- Remote monitoring via web
- Environmental monitoring
- Extensive alarm handling and dispatching
- Redundant UPS monitoring
- Integration into network or building management system
- Integration into multivendor and multiplatform environments
- ModBus interface
- Multiple standard protocols are supported

Applications

- Personal computers
- Servers and network devices
- Data centers
- Storage systems
- Industrial automation
- Power systems

AS400 and Mini AS400

AS400 and Mini AS400 are two plug-and-play cards installed in the UPS intelligent slot. They provide dry contact signals to inform

the user about different UPS operative statuses and send alerts in case of disruptions:

Alarms

- AC mains failure
- UPS fault
- UPS running in bypass mode
- Communication error
- Battery low

Indicator

- Bypass active
- UPS ON

Additionally, these cards provide input dry contacts to switch the UPS on and off.

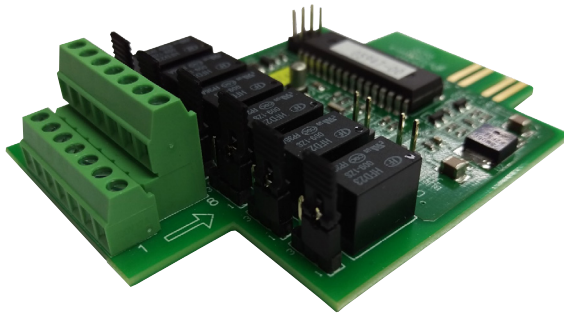

Product description	Article number
AS400 slot card with dry contacts	4NWP100120R0001
AS400 mini slot card with dry contacts	4NWP100120R0002
AS400 slot card with dry contacts (for 11RT G2 1-3 kVA)	4NWP100220R0001

Table 9: Ordering info table

Winpower and WebPro

The Winpower and WebPro series are the budget solution that enables the integration of the UPS within Ethernet and ModBus networks.



With Winpower and WebPro slot cards, the operator can easily monitor the UPS status and send commands through a user-friendly web-based interface to control the UPS itself; the same action is also possible via a network management software that supports the SNMP protocol. Winpower and WebPro are easy to install in the UPS intelligent slot and they are both provided along with a CD containing SPS software, a must-have utility to program the remote shutdown of the most common server platforms.

EMP (Environmental Monitoring Probe) is a multi-sensor that collects external temperature and relative humidity data in the environment where the UPS has been installed.



It is easily connected to Winpower and WebPro cards and enables the operator to remotely monitor these crucial parameters to correctly operate the UPS.



Additionally, it alerts the system administrator in case temperature and relative humidity values go beyond pre-set thresholds.

Winpower and WebPro ModBus slot cards enable UPS monitoring and control via ModBus protocol over RS232 or RS485.

The cards provide two serial interfaces and a RS232/RS485 conversion.

Product description	Article number
Winpower SNMP card	4NWP100110R0001
Mini Winpower SNMP card	4NWP100110R0002
Winpower ModBus card	4NWP104039R0001
Mini Winpower ModBus card	4NWP104039R0002
WebPro SNMP card (for 11RT G2 1-3 kVA)	4NWP100230R0001
WebPro ModBus card (for 11RT G2 1-3 kVA)	4NWP100221R0001
EMD for Winpower and Mini Winpower	4NWP104040R0001
EMD for WebPro	4NWP100222R0001

Table 10: Ordering info table

CS141

CS141 represents the ABB premium connectivity offering by providing the user with a full set of products and accessories for UPS remote monitoring and control.

Available in three models (Base, Advanced, and ModBus) and two different formats (slot and box),

CS141 enables the IoT concept and simplifies the integration of the UPS within the network to bring the operator the state-of-art UPS monitoring technology.

All CS141 products are provided with one free RCCMD client and UPS monitoring software.

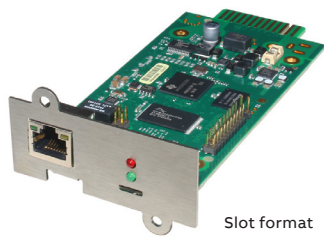

Slot format

CS141 Basic

For interfacing the UPS to the network without the need for additional sensors or interfaces. Available in slot and box formats.

Supports the following protocols

1 HTTP	4 ModBus TCP
2 SNMP	5 Telnet FPT
3 SMTP (e-mail)	

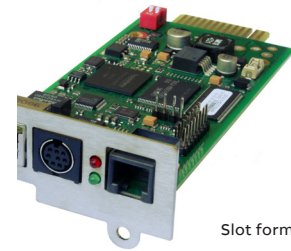

Slot format

CS141 Advanced

For interfacing the UPS to the network and allowing users to connect additional sensors and I/O options either directly to the card or via sensor manager. Available in slot and box formats.

Supports the following protocols

1 HTTP	4 ModBus TCP
2 SNMP	5 Telnet FPT
3 SMTP (e-mail)	6 ModBus RS-232



Box format

CS141 ModBus

For interfacing the UPS to the network and the ModBus RS-485 with an option to connect alarm buzzers or an additional relay board. Available in slot and box formats.

Supports the following protocols

1 HTTP	4 ModBus TCP
2 SNMP	5 Telnet FPT
3 SMTP (e-mail)	6 ModBus RS-485

Slot cards are UPS-powered, while cards in box format require external power.

Connectivity and sensor options for CS cards and boxes

Basic

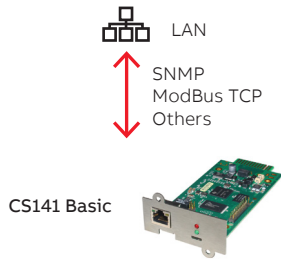

No peripherals

ModBus

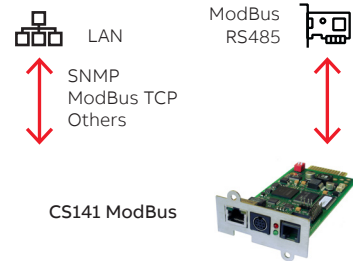

Advanced

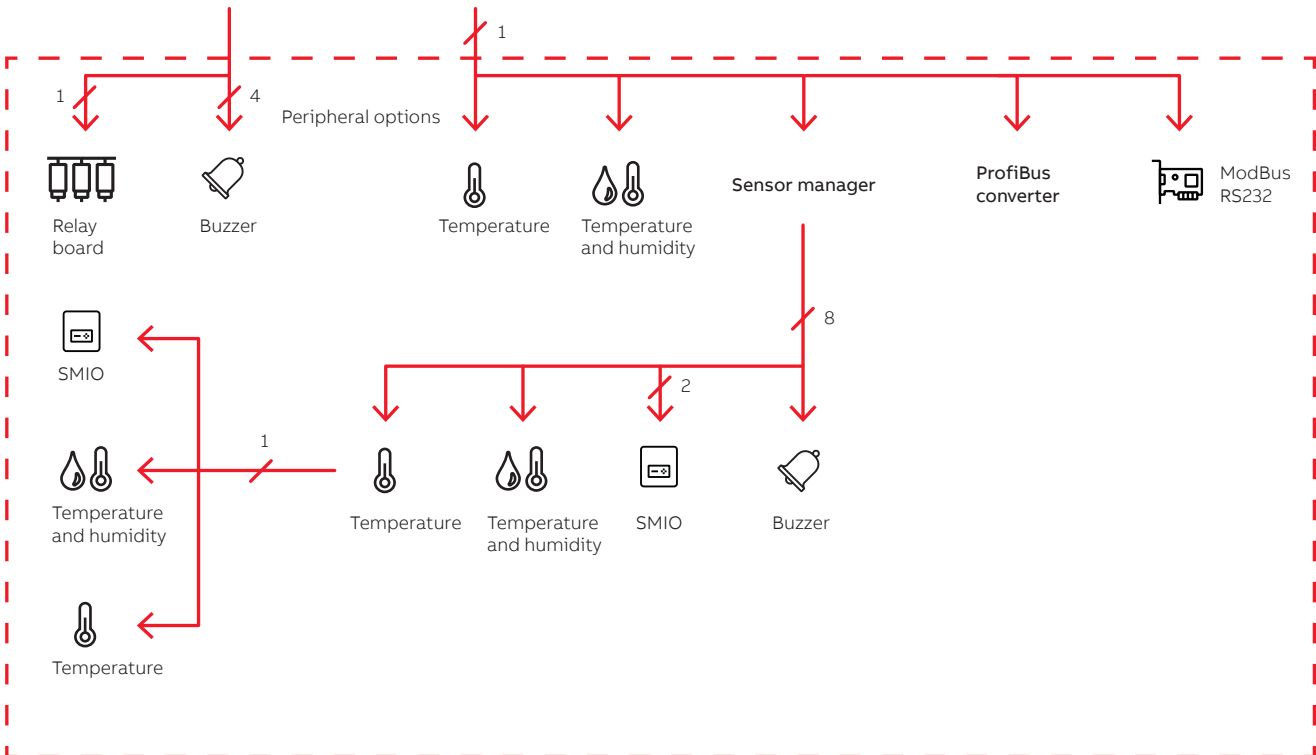
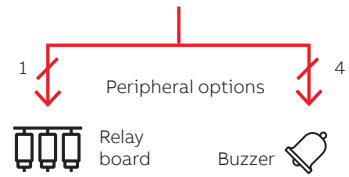
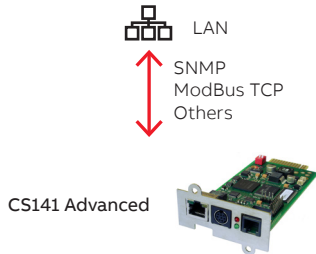

List of connectivity and sensor options for different network interfaces

		Article number	Product description	Details			
CS141	Network interface*	4NWP102687R0001	Box CS141	Web/SNMP interface ModBus TCP	No sensor options		
		4NWP102688R0001	Slot Basic		No aux options		
		4NWP102879R0001	Box CS141		Optional sensors		
		4NWP102880R0001	Slot Advanced		Aux connection		
		4NWP102881R0001	Box CS141		ModBus RS845		
		4NWP102882R0001	Slot ModBus		Aux connection		
	I/O options		4NWP103268R0001	Alarm buzzer CS141	Buzzer, 60 dB	5 m cable	
			4NWP103097R0001	Relay board CS141	4 digital inputs 4 relay outputs	1 m cable	
			04-0594	Profibus converter	External DIN rail mount device		
			00-6944	Temperature sensor	-25 °C to +100 °C, ±0.5%	1.8m cable	
			04-3880	Combisensor for temperature and humidity	-25 °C to +100 °C, ±0.5% 0% to 100% RH, ±5%	1.8m cable	
			00-5915	Sensor manager	Environmental interface		
			00-5916	Temperature sensor	0 °C to +100 °C, ±0.5%	5 m cable	
			00-6948	Combisensor for temperature and humidity	0 °C to +100 °C, ±0.5% 0% to 100% RH, ±5%	5 m cable	
			00-6945	Alarm buzzer	85 dB	5 m cable	
			00-6947	Relay box	1 input contact 1 output contact	5 m cable	
	RCCMD		04-3869	RCCMD license	For Windows, Linux, MAC X, OS / 2, UNIX, NOVELL		
			04-3870	RCCMD license	For IBM AS 400 V4R5, V5, V6, V7		
			01-0014	RCCMD enterprise license	>50 licenses (Windows, Linux, MAC X, OS / 2, UNIX, NOVELL)		

Table 11: Ordering info table

9b Electrical options

ATS-16



The ATS-16 is a two-way, single-phase, automatic switch powered by two independent synchronous or asynchronous AC power supply sources (typically two feeding UPSs upstream).

One of the two sources can be designated as the preferred power supply, to which the ATS-16 will transfer the load. The ATS-16 promptly switches to the other source in the event of primary source failure.

Easy to install in a rack-mount (1RU only) or vertical configuration, the ATS-16 has an intuitive interface with LED indicators and push buttons.

The ATS-16 enhances the system reliability due to internal back-feed protection and complete protection for overload and short-circuit.

Product description	Article number
ATS-16	4NWP104041R0001

Table 12: Ordering info table

External maintenance bypass with PDU



The external maintenance bypass with PDU delivers a maintenance bypass feature and convenient power distribution.

This enables the user to service the UPS in a safe and proper manner by excluding any risk for the operator while the load is powered by the AC mains.

This feature is available for the PowerValue 11RT G2 entire range. The PowerValue 11RT G2 UPS within the 6-10 kVA range offers a unique mounting concept with 0 RU occupied in the installation due to flexible mounting brackets.

Product description	Article number
External maintenance bypass with PDU PowerValue 11RT G2 1-3 kVA	4NWP101737R0001
External maintenance bypass with PDU PowerValue 11RT G2 6-10 kVA	4NWP101737R0002

Table 13: Ordering info table

9c Mechanical options

Rack mounting kit for PowerValue 11RT G2

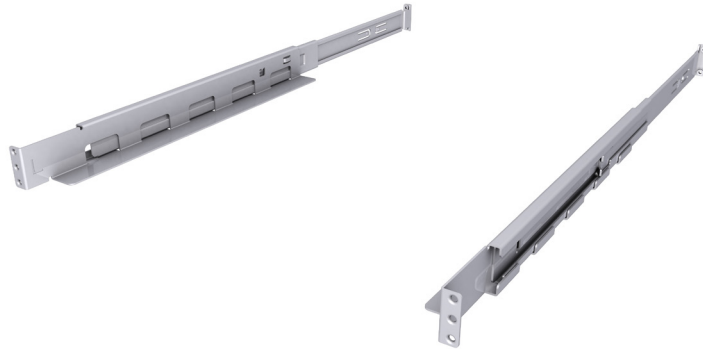

Mechanical kit made by 2 rails to fit the PowerValue 11RT G2 UPS and EBM within a standard 19" rack.

Product description	Article number
Rack mounting kit PowerValue 11RT G2 1-3 kVA (UPS and EBM)	4NWP100211R0001
Rack mounting kit PowerValue 11RT G2 6-10 kVA (UPS)	4NWP100111R0003
Rack mounting kit PowerValue 11RT G2 6-10 kVA (EBM)	4NWP100111R0004

Table 14: Ordering info table

10 Warranty matrix and extension pricelist

A flexible lifetime warranty plan is available to provide coverage for the UPS.

The optional warranty extension must be purchased at the time of the UPS purchase. The warranty protects the UPS only (not the batteries).

Product family	Base warranty	Warranty extension	Warranty extension article number
PowerValue 11LI Up/Pro 600-2000 VA	2 years	-	-
PowerValue 11T G2 1-3 kVA	2 years	1 year (max 3 years)	4NWP104078R0001
PowerValue 11T G2 6-10 kVA	2 years	1 year (max 3 years)	4NWP104079R0001
PowerValue 11RT G2 1-3 kVA	3 years	1 year (max 2 years)	4NWP104078R0001
PowerValue 11RT G2 6-10 kVA	3 years	1 year (max 2 years)	4NWP104079R0001
PowerScale 11/31T 10-20 kVA	2 years	1 year	4NWP101080R0001
PowerScale 33 10-25 kVA (cab A,B)	1 year	1 year	00-5517
PowerScale 25-50 kVA (cab C)	1 year	1 year	04-3254

Table 15: Warranty matrix and extension pricelist



—
abb.com/ups



© Copyright 2018 ABB. All rights reserved.
Specifications subject to change without notice.

4NWP104969R0001_EN